

HANDBOOK



No. 06-22

Jun 06

SECURITY FORCE

Tactics, Techniques, and Procedures

Center for Army Lessons Learned (CALL)

<http://call.army.mil>

Combined Arms Center (CAC) • Ft. Leavenworth, KS

**U.S. UNCLASSIFIED
REL NATO, GCTF, ISAF, MCFI, ABCA
For Official Use Only**

Handling Instructions for CALL Electronic Media and Paper Products

Center for Army Lessons Learned (CALL) authorizes official use of this CALL product for operational and institutional purposes that contribute to the overall success of U.S., coalition, and allied efforts.

The information contained in this product reflects the actions of units in the field and may not necessarily be approved U.S. Army policy or doctrine.

This product is designed for official use by U.S., coalition, and allied personnel and cannot be released to the public without the expressed written consent of CALL. This product has been furnished with the expressed understanding that it will be used for official defense-related purposes only and that it will be afforded the same degree of protection that the U.S. affords information marked "U.S. UNCLASSIFIED, For Official Use Only [FOUO]" in accordance with U.S. Army Regulation (AR) 380-5, section 5-2.

Official military and civil service/government personnel, to include all coalition and allied partners may paraphrase; quote; or use sentences, phrases, and paragraphs for integration into official products or research. However, integration of CALL "U.S. UNCLASSIFIED, For Official Use Only [FOUO]" information into official products or research renders them FOUO, and they must be maintained and controlled within official channels and cannot be released to the public without the expressed written consent of CALL.

This product may be placed on protected UNCLASSIFIED intranets within military organizations or units, provided that access is restricted through user ID and password or other authentication means to ensure that only properly accredited military and government officials have access to these products.

Regulations strictly forbid posting CALL "U.S. UNCLASSIFIED, For Official Use Only [FOUO]" documents to Department of Defense (DOD) Websites that do not restrict access to authorized personnel. AR-25-1, 15 Jul 2005, Army Knowledge Management and Information Technology, paragraph 6-4 n (2) (b) and DOD Web Site Administration Policy and Procedures (11 Jan 2002), Part II, paragraph 3.6.1 require appropriate mechanisms to protect sensitive information.

When no longer needed, all CALL "U.S. UNCLASSIFIED, For Official Use Only [FOUO]" paper products and electronic media will be shredded or destroyed using approved paper shredders or CDROM destroyers.

To allied and coalition personnel:

This information is furnished with the understanding that it is to be used for defense purposes only, that it is to be afforded essentially the same degree of security protection as such information is afforded by the United States, and that it is not to be revealed to another country or international organization without the written consent of CALL.



FOREWORD

From 28 Feb 06 to 18 Apr 06, a five-man Combat Arms Assessment Team from the 2-315th Field Artillery Transportation Support Battalion focused on collecting the most current security force convoy tactics, techniques, and procedures (TTP) in the Iraq Theater. The focus of this collection was convoy security force actions before, during, and after convoy operations including personal security detachment, escort of civilian vehicles (convoy security), and self escort of military convoys.

The team visited over 15 units in the Baghdad, Tikrit, and Mosul areas of operation. This handbook is a collection of the best TTP, products, and SOPs for security force operations from each location. The intent of the handbook is to provide insight into security operations in Operation Iraqi Freedom and a general convoy standing operating procedure (SOP) for security forces in the Iraq Theater.

A handwritten signature in black ink, appearing to read 'S. Mains', with a horizontal line extending to the right.

Steven Mains
Colonel, Armor
Director
Center for Army Lessons Learned

Security Force Handbook	
Table of Contents	
Foreword	i
Chapter 1: Introduction	1
1. The Basic Security Force Unit	1
2. Types of Security Force Missions	2
a. Convoy Security	2
b. Personal Security Detachment	2
c. Site Security	3
d. Other Missions	3
Chapter 2: Pre-Convoy Operations	5
1. Duties and Responsibilities	5
a. Squad Leader/Convoy Commander	5
b. Truck Commander/Team Leader	6
c. Gunner	7
d. Driver	7
e. Other Designated Teams	8
2. Pre-combat Checks/Pre-combat Inspections	9
3. Load Plan	15
4. Weapon Systems	16
a. M2 .50 Caliber Machine Gun	16
b. M240B Machine Gun	17
c. M249 Machine Gun	18
d. MK19 40-mm Machine Gun	19

CENTER FOR ARMY LESSONS LEARNED

e. Additional Weapons	19
f. Weapons Clearing and Functions Check	21
5. Communications	25
a. Single-Channel Ground and Airborne Radio System/Advanced System Improvement Program	25
b. Vehicle Intercommunication System	28
c. Force XXI Battle Command Brigade and Below/Blue Force Tracker	28
d. Movement Tracking System	29
e. Alternate Means of Communication	29
f. Communication Preventative Maintenance Checks and Services	34
6. Rehearsals	34
7. Common Vehicle Maintenance Issues	35
8. Mission Brief	37
9. Convoy Brief	38
10. Convoy Manifest	39
Chapter 3: During Operations	41
1. Duties and Responsibilities	41
a. Squad Leader/Convoy Commander	41
b. Truck Commander/Team Leader	41
c. Gunner	42
d. Driver	42
2. Mission Considerations	43
a. Personal Security Detachment	43
b. Convoy Security	43

c. Enemy Implementation of Improvised Explosive Devices (IEDs)	44
d. IED Trends	44
e. VBIED Trends	46
f. Characteristics of VBIEDs	46
3. Communications	47
a. Voice and Digital Communications	47
b. Commonly Used Iraqi Words	48
4. Battle Drills	51
a. React to Detonated IED	51
b. React to a Suspected or Identified IED While on Convoy	55
c. React to Vehicle-Borne IED (VBIED) While on Convoy	58
d. React to Block/Unblocked Ambush: Small Arms Fire, Rocket Propelled Grenade, Grenade	62
e. Hasty/Deliberate Recovery on Downed Vehicle	66
f. React to a Congested Area	67
g. Overpass Battle Drill	71
h. Gunner Down Drill	73
i. Driver Down Drill	74
j. Vehicle Rollover Drill	74
k. Crew-Served Weapon Down During Enemy Contact Drill	76
l. Fixed Site Security in Open Area	76
m. Securing the Area Around a Building Battle Drill	78
n. Blocking Techniques: Traffic Circle, Intersection, On/Off Ramp	81

CENTER FOR ARMY LESSONS LEARNED

o. Reloading Ammunition Battle Drill	83
p. Casualty Evacuation Battle Drill	84
5. Protection Considerations	85
6. Weapons Employment	88
7. Recovery Operations	89
8. Medical Considerations	91
9. Battle Tracking	92
a. Battle Tracking Tools	92
b. Battle Tracking Requirements	92
Chapter 4: Post Operations	95
1. Duties and Responsibilities	95
a. Squad Leader/Convoy Commander	95
b. Truck Commander/Team Leader	95
c. Gunner	95
d. Driver	96
2. Closure Report	96
3. Debrief	96
4. After Action Review	98
5. Maintenance	98
6. Killed in Action Considerations	99
a. Actions	99
b. Administrative Considerations	100
Annex A: Types of Convoys Escorted	103
Annex B: M2 Machine Gun Components	105

M2 High Mobility Multipurpose Wheeled Vehicle (HMMWV) Pedestal	106
M2 Vehicle Ring Mount	107
M2 Mounting Accessories	108
Annex C: M240B Machine Gun Components	109
M240B Mounting Accessories	110
Annex D: M249 Machine Gun Components	111
M249 HMMWV Pedestal	112
M249 Vehicle Ring Mount	113
M249 Mounting Accessories	114
Annex E: MK19 Machine Gun Components	115
MK19 HMMWV Pedestal	116
MK19 Vehicle Ring Mount	117
MK19 Mounting Accessories	118
Annex F: Quality Assurance/Quality Control Checklist	119
Annex G: Reports	123
Medical Evacuation, Improvised Explosive Device/Unexploded Ordnance, Spot Report, Size, Activity, Location, Unit, Time, and Equipment, Contact, and Ammunition, Casualty, and Equipment	123
<p>The collection team thanks the numerous units and Soldiers who contributed information and personal knowledge for inclusion in this handbook. We appreciate all that you have done for our country.</p>	

CENTER FOR ARMY LESSONS LEARNED

Center for Army Lessons Learned

Director	Colonel Steven Mains
Managing Editor	Jim Walley
CALL Analyst	Joe Fox
Contributing Authors	SFC Stephan Gomez SFC James Tilley SFC William Stephens CPT Augustus Tutu MAJ Luis Fregoso
Production Manager	Valerie Tystad
Editor	Patricia McAllister
Graphic Artist	Mark Osterholm

The Secretary of the Army has determined that the publication of this periodical is necessary in the transaction of the public business as required by law of the Department. Use of funds for printing this publication has been approved by Commander, U.S. Army Training and Doctrine Command, 1985, IAW AR 25-30.

Unless otherwise stated, whenever the masculine or feminine gender is used, both are intended.

Note: Any publications referenced in this newsletter (other than the CALL newsletters), such as ARs, FMs, and TMs, must be obtained through your pinpoint distribution system.

Chapter 1

Introduction

1. The Basic Security Force Unit

Throughout the Iraqi theater, units tailor security forces in order to meet the requirements of the mission. The equipment used is also modified depending on the operating environment. However, most security forces share common building blocks used in this handbook.

Tactics, techniques, and procedures (TTP) in this handbook are based on the model of a common base security force unit. The basic security force platform is generally the M1114, the XM1117 (armored security vehicle), the RG31 (multipurpose vehicle), or an equivalent gun truck. Designated security force companies are currently equipped with the M1114s as their main gun truck. Each platform has a minimum of three Soldiers: a truck commander, gunner, and driver.



Figure 1-1: Basic security force platform

One squad (section for artillery security force units) consisting of four platforms is the standard package for most missions. The squad conducts autonomous security force missions and is left alone at combat outposts for long stretches. Squads are the most common organization receiving the security force missions discussed in this handbook.

Below is the general organization of a security force squad:





			
Convoy Commander (SSG) (Squad Leader) Gunner (SPC) Driver (PFC)	Truck Commander (SGT) (Team Leader) Gunner (SPC) Driver (PFC)	Truck Commander (SGT) (Team Leader) Gunner (SPC) Driver (PFC)	Truck Commander (SGT) (Team Leader) Gunner (SPC) Driver (PFC)

Figure 1-2: Security force squad

Modification tables of organization and equipment (MTOE) designated security force units can be task-organized to any battalion. Generally security force units are not task-organized below company/battery level; however, it is common to see platoons designated a specific mission for extended periods of time, i.e., as a police transition team (PTT), convoy security, or personal security detachment (PSD). Many company-size units (usually field artillery) are transforming into MTOE security force companies. MTOE security force companies consist of three platoons plus an additional platform for the commander. Each platoon consists of three squads, plus an additional platform for the platoon leader. This composition gives the company a total of 40 platforms plus additional vehicles for support personnel.

Most battalions also have an internal security force unit primarily for PSD and occasionally for convoy security. The composition of these internal security forces depends on platform availability, type of mission, and scope of the operation. This handbook also provides these types of security forces valid TTP, as well as common before, during, and after considerations for their operations.

2. Types of Security Force Missions

a. **Convoy security.** Both military and civilian convoys are subject to attack from insurgents, necessitating constant security. While most military convoys will have an internal security force, civilian convoys do not have that capability. For this reason security forces are often tasked to escort convoys consisting of two or more vehicles. The size of the convoy determines the number of required security force squads. The general rule of thumb is one platform (M1114) for every five vehicles in the civilian convoy. Platoon leaders may choose to add platforms to squads or lead a mission with multiple squads. (**Note:** Types of convoys often escorted are listed in Annex A).

b. **PSD.** PSD is conducted regularly by almost every unit in Operation Iraqi Freedom. PSD may include the security of a unit commander or sergeant major, a dignitary or local leader, or even a detainee. Security forces are charged with escorting VIPs from point A to point B. Given the operating environment in Iraq, a

well-trained PSD is essential for the safety of VIPs and the Soldiers conducting the missions.

c. **Site security.** Security forces may be required to conduct site security as part of their convoy operations. Depending on the type of mission, site security may require Soldiers to conduct dismounted security. Examples of site security where Soldiers dismount include restricting access to an area due to an improvised explosive device or providing security around a building in a populated area.

Examples of site security where Soldiers do not dismount include waiting for recovery assets while the squad provides security for a downed vehicle or road security when a squad is required to secure access into an alternate supply route.

d. **Other missions.** While other missions are beyond the scope of this handbook, it is important to note security forces conduct numerous other types of missions.

The most current (FY 2006) critical mission is training the Iraqi Police (IP). This mission requires security forces and MP units to link and develop habitual relationships with the IP. Some units man the IP basic training academies, while others monitor IP station progress and provide additional training. This mission also requires Soldiers to fully understand how Iraqis conduct business. Soldiers must be prepared to conduct a variety of classes with the assistance of an interpreter. Knowledge of basic police station administrative requirements will assist in this mission.

Another common mission is detainee operations. Most forward operations bases (FOBs) have some sort of detainee facility. The responsibility for maintaining security inside and outside the facility often falls to security forces. This responsibility includes the daily health and welfare of the inmates and their administrative and logistical requirements, as well as the movement of detainees within the FOB or to other sites. Occasionally security forces will transport detainees by air to distant FOBs.

When contact is made with the enemy, security forces must be prepared to engage and destroy the enemy. Security forces should develop basic contact battle drills aimed at maneuvering, fixing, and eliminating the enemy.

Chapter 2

Pre-Convoy Operations

1. Duties and Responsibilities

a. **Squad leader (SL)/Convoy commander.** The SL supervises the training, counseling, and development of 12 squad members. The squad usually has an Arabic-speaking interpreter assigned to the convoy. The SL is in charge of four platforms (M1114s) and may occasionally receive additional platforms for the duration of larger missions. The SL's pre-convoy duties include the following:

- Reviews intelligence reports daily to attain latest information prior to a mission.
- Receives the warning order and starts troop-leading procedures.
- Prepares the mission packet and turns it in to the operations center. The mission packet consists of convoy manifest, mission statement (operations order [OPORD]), vehicle equipment status, latest intelligence update, order of march, route, frequencies of land owners within mission route, pre-combat inspections [PCI] checklist, and an objective sector sketch with objective grids and platform positioning).
- Receives and briefs the OPORD to the squad.
- Verifies communications checks are conducted with higher headquarters (HQ) in accordance with (IAW) unit standing operating procedures (SOP).
- Fills out all appropriate forms and reports IAW requirements listed in unit SOP.
- Requests and confirms that ammunition, water, rations, and special equipment (spotlights, lasers, etc.) are issued.
- Maintains accountability for sensitive items.
- Verifies function checks conducted on weapons systems.
- Ensures frequency-jamming devices are working properly.
- Confirms everyone has their personal protective equipment (individual equipment on pre-combat checks [PCC]).
- Checks that the squad has required equipment and cross-levels equipment as necessary.
- Arranges and allocates logistical support.
- Uses the Convoy Planning Tool program to properly position electronic countermeasure assets (check with HQ to obtain this classified program).

CENTER FOR ARMY LESSONS LEARNED

- Verifies all digital devices (Force XXI Battle Command Brigade and Below [FBCB2]/Blue Force Tracker [BFT], Movement Tracking System [MTS], etc.) are functioning IAW SOP.
- Supervises PCC and conducts PCI for convoy platforms.

b. Truck commander (TC)/Team leader. One of the team leaders is designated as the assistant convoy commander. He must be prepared to assume the duties of the convoy commander and accomplish the mission in the event the designated convoy commander is unable to do so. Other duties of the TC include the following:

- Ensures the driver is licensed on assigned vehicle (driver should have a 5984E, U.S. Government Motor Vehicle Operators Identification Card).
- Develops a driver and gunner rotation plan for long convoys.
- Battletracks his position and announces to the convoy commander when passing a checkpoint.
- Confirms that his team knows what to look for on the mission and collects intelligence data for debriefing upon the completion of the mission.
- Watches the terrain and route for enemy activity.
- Attains all required classes of supply for his platform.
- Makes certain the gunner is qualified on assigned weapons.
- Conducts communications check with convoy commander.
- Checks that all assigned platform navigational equipment is working properly.
- Conducts map reconnaissance of route and destination.
- Ensures platform team understands actions to be taken after arriving at the objective.
- Conducts platform rehearsals.
- Maintains accountability of crew throughout entire mission.
- Confirms all Soldiers understand and can deliver the following reports: 9-line medical evacuation (MEDEVAC), 9-line unexploded ordnance (UXO)/improvised explosive device (IED), size, activity, location, unit, time, and equipment (SALUTE), and ammunition, casualties, and equipment.
- Accomplishes assigned PCC and PCI.

c. **Gunner.** The gunner is in charge of the force protection for his platform as well as the convoy. The gunner is most exposed to enemy contact and must be well-trained on his weapon. He must understand the local rules of engagement (ROE) and internalize the requirements and rules of escalation of force (EOF). Some of his duties include the following:

- Knows the current enemy trends and enemy's tactics, techniques, and procedures (TTP) in order to obtain situational awareness prior to beginning the mission.
- Recognizes the newest forms of IEDs and what to look for while on the convoy.
- Attaches all weapons on their appropriate mounts and verifies they are properly installed; confirms headspace and timing and conducts a functions check for each weapon system to ensure their operability.
- Qualifies on all weapons: the M2, MK19, M240B, M249, M16/M4, and M9. Conducts immediate action on all weapons and troubleshoots for any problems.
- Performs headspace and timing on crew-served weapons prior to each mission.
- Learns basic Arabic words in order to give directions. Directs traffic using hand and arm signals. Uses non-lethal and lethal means in accordance to the rules outlined for EOF.
- Conducts the 5-25 meter scan with a high power light at night to locate IEDs or anything unusual on the route.
- Dons and removes the Cupola Protective Ensemble (CPE).
- Secures assigned harness equipment (5-point restraint harness, gunner seat) and quickly dismounts.
- Completes all assigned PCC.

d. **Driver.** The driver is responsible for the safe operation of the vehicle from the start point to mission completion. The driver must be familiar with FM 21-305, *Manual for the Wheeled Vehicle Driver*, and the appropriate technical manual for his platform, as well as the TMs for all equipment inside the vehicle. The driver must also be trained to drive under adverse conditions (night, sandstorms) and be prepared to take a shift as the gunner on long missions. Drivers should be licensed and trained on the assigned vehicle and have basic maintenance skills in order to conduct hasty vehicle maintenance. Other responsibilities of the driver:

- Understands how to use all platform equipment (including winch).
- Acquires familiarity with the mission route.

- Loads, secures, and tarps cargo to prevent loss due to shifting, inclement weather, or possible pilferage.
- Completes individual driver trip records (mileage, trips, times, oil and fuel added) and notes any equipment malfunctions.
- Ensures an accident kit is in his vehicle (SF91, Motor Vehicle Accident Report, disposable camera).
- Conducts preventive maintenance checks and services (PMCS) on assigned vehicle and updates.
- Ensures enough water and rations are available for the current mission.
- Loads communications security (COMSEC) and frequencies into assigned communications equipment.
- Checks that vehicle is at maximum fuel capacity before mission.
- Ensures the load plan is properly maintained.
- Completes all assigned PCC.

e. Other designated teams:

Combat lifesavers (CLS)/medics. The CLS and medics are responsible for rendering medical treatment and supervising evacuation of casualties. When possible, multiple CLS should be assigned (at least one per vehicle), dispersing assets throughout the convoy. CLS should be assigned responsibility for specific vehicles in order to streamline medical attention.

Aid and litter (A&L) team. A&L teams, consisting of two to four Soldiers, are responsible for providing buddy aid and preparing casualties for movement and/or evacuation under supervision of the CLS or medic. When possible, multiple teams should be assigned, spreading assets throughout the convoy. A&L teams should be assigned responsibility for specific vehicles in order to speed medical assistance. If CLS are limited, they should be chosen last for the A&L team.

The A&L designated vehicle should be able to easily receive injured personnel and have sufficient armor to protect the injured. The A&L vehicle should have a space cleared out for casualties at all times and be prepared for carrying injured personnel at any time. The A&L team must also have body bags available in the event of fatalities.

Landing zone (LZ) team. The LZ team is responsible for selecting, securing, clearing, establishing, and marking the LZ site. This team must have LZ marking equipment (VS-17 panel, smoke, chemical lights [see Figure 2-1]) in the event of needing air MEDEVAC. If there are enough personnel, assign an alternate team.

This team must also consider the safety of the air support assets and the possibility of secondary IEDs targeting the landing aircraft.



Figure 2-1: LZ marking equipment

Recovery team. All platforms should be prepared to recover vehicles of the same type (vehicles in a convoy should have at least one other vehicle of the same type or size in the convoy). In the event a larger vehicle in the convoy does not have an available equivalent, the recovery team must be prepared to push or pull the disabled vehicle. Ideally a maintenance wrecker should accompany a convoy with large vehicles (2 tons or more). If possible, equipment for hasty maintenance support should be brought with the convoy. At a minimum, the convoy commander must have the means and frequency to call land owners along the route for recovery support. In the case of having to request recovery support from a land owner, the convoy must provide fixed site security until a local recovery team arrives.

2. PCC/PCI

PCC are procedures for Soldiers assigned to a convoy to determine if equipment required for a mission is available and serviceable. PCC are effective only if organized and conducted using an up-to-date checklist. The type of unit, equipment, operational area, and mission dictates additions, substitutions, and deletions. Follow-through is essential. These checks should be scheduled soon after the warning order is issued, at a time when Soldiers are released from other duties.

PCI are a series of inspections scheduled early in the preparation sequence to ensure that all PCC have been performed properly, and vehicles, weapons, communications, special, and individual equipment are available and functional. PCI are most effective when organized and conducted to exacting standards by first-line supervisors with systematic spot checks made by the next level leadership.

A suggested checklist for security force operations follows:

CENTER FOR ARMY LESSONS LEARNED

Task		Completed by/inspected by	Remarks
Individual Equipment			
1	Identification tags (ID) and ID card	All/TC	
2	Weapons cleaning kit	All/TC	
3	ROE card	All/TC	
	Unit tactical SOP	All/TC	
	Flashlight (and extra batteries)	All/TC	
	Ballistic eye protection	All/TC	Clear inserts for night operations
	Gloves	All/TC	
	Hearing protection	All/TC	
	M40 protective mask, Joint Service Lightweight Integrated Suit Technology, Atropine injector, Doxycycline tablets	All/TC	Kept in Individual Chemical Equipment pack
	Individual weapon and basic load	All/TC	Spare barrel if applicable
	Notebook and pen	All/TC	
	Watch	All/TC	On Precision Lightweight GPS Receiver (PLGR) time
	Compass (if issued)	All/TC	
	Ruck packed IAW unit SOP	All/TC	Special equipment/overnight gear
	Interceptor Body Armor System (IBAS) with Enhanced Small Arms Protective Inserts (ESAPI) plates	All/TC	
	Dorsal Auxiliary Protection System (DAPS)	All/TC	With IBAS
	Kevlar/Modular Integrated Communications Helmet	All/TC	
	Knee and elbow pads	All/TC	
	Night vision device and extra batteries	All/TC	Test for serviceability

SECURITY FORCE HANDBOOK

	First aid pouch with sterilized compression pad	All/TC	DA Form 1156 draft 15 Jul 05 Casualty Feeder Report in pouch
	Two copies of casualty feeder card	All/TC	DA Form 1156 draft 15 Jul 05
	Full water source (canteens/CamelBak)	All/TC	
	Battle roster numbers displayed on Kevlar	All/TC	Ensure HQ has correct battle roster numbers
	Blood type displayed IAW unit SOP	All/TC	
	Road guard vests	All/TC	
	Military drivers license	Driver/TC	
	Headspace and timing tool for M2	Gunner/TC	
	Ballistic face shield/CPE	Gunner/TC	
	Binoculars	TC/SL	
	Digital camera (with extra batteries)	TC/SL	
	Patrol debrief sheet readily available	SL/PSG	
	Identification tags on boots	All/TC	
Vehicle Checks			
	Vehicle Dispatch and 5988E (Equipment Inspection and Maintenance Worksheet) current	Driver/TC	
	Graphic Training Aid Cards: 9-line MEDEVAC/U XO/IED	Driver/TC	Posted IAW unit SOP
	Operational PLGR/Defense Advanced GPS Receiver (DAGR) and spare battery	Driver/TC	External antenna
	Spotlight	Driver/TC	Ensure it is operational
	Tow bar or tow strap	Driver/TC	Check for serviceability
	Warning triangles/warning cones	Driver/TC	
	Basic issue item (BII) for vehicle	Driver/TC	
	Spare tire	Driver/TC	

CENTER FOR ARMY LESSONS LEARNED

	Two fire extinguishers	Driver/TC	Ensure they are filled
	Motor oil and transmission fluid	Driver/TC	
	Rubber gloves for each vehicle occupant	Driver/TC	Kept in CLS bags
	Spare fuel cans topped off and tied down	Driver/TC	
	Box of meals ready to eat (MRE)	Driver/TC	
	Two cases of water	Driver/TC	
	Medical/biological cleanup kit	Driver/TC	
	Window cleaner and paper towels	Driver/TC	Keep paper towels in a bag
	Body bag	Driver/TC	
	Everything secured and tied down	Driver/TC	
	Vehicle fuel topped off	Driver/TC	
	Litter	Driver/TC	At least one per squad
	Pre-operations PMCS completed	Driver/TC	
	VS-17 panel	Driver/TC	
	All counter IED devices operational	Driver/TC	
	Crow functioning properly	Driver/TC	
	Barbed wire	Driver/TC	
	Vehicle gunner restraint harness system	Gunner/TC	
	Laser	Gunner/TC	
	Siren	TC/SL	Ensure it is operational
	Incident/accident package 581 (US/IRAQI)	TC/SL	
	CLS and contents	TC/SL	Inventory contents and check dates
Communications/Digital Equipment			
	Antennas properly mounted and serviceable	Driver/TC	Clean connections

SECURITY FORCE HANDBOOK

	Single-Channel Ground and Airborne Radio System (SINCGARS)/Advanced System Improvement Program (ASIP) Man-Pack and two extra batteries	Driver/TC	At least one per squad
	All SINCGARS/ASIPS have proper fill and are on the correct frequency	Driver/SL	
	Internal headsets working in platform	Driver/SL	Minimum three per platform
	FBCB2, BFT, or MTS powered and working properly	TC/SL	
	Latest graphics uploaded on FBCB2	TC/SL	
	Communications (commo) checks conducted from all platforms to the convoy commander using FBCB2/MTS and SINCGARS/ASIPs, Integrated Communications (ICOM)	TC/SL	
	Commo checks conducted with HQ using FBCB2/MTS, SINCGARS/ASIP, and cell phone	SL/platoon sergeant (PSG) or platoon leader (PL)	Squad leader makes internal commo checks within squad
	Collected all frequencies of landowners along the route used during the mission	SL/PSG or PL	Squad leader gives copies to all TCs
Weapons (Kinetic and Non-Kinetic)			
	Weapons clean and serviceable	All/TC	Ensure weapons PMCS completed
	Functions check conducted on all weapons	All/TC	
	Gunners know sectors of fire	Gunner/TC	
Ammunitions and Pyrotechnics			
	Appropriate pyro on hand	Gunner/TC	Smoke, star clusters, parachute flares
	M9 – 30 rounds per system	TC/SL	
	M4/M16 – 210 rounds per system	TC/SL	
	M249 – 600 to 800 rounds per system	TC/SL	
	MK19 – 3 cans (144 rounds) per system	TC/SL	
	M2 – 3 cans (300 rounds) per system	TC/SL	
	00 buck shot – (--- rounds) per system	TC/SL	
	Fragmentary hand grenade	TC/SL	

CENTER FOR ARMY LESSONS LEARNED

	Thermite grenade	TC/SL	
	Less than lethal ammunition per patrol (if issued):	TC/SL	
	- CS grenades	TC/SL	
	- 40-mm rubber ball, sting	TC/SL	
	- 40-mm foam baton	TC/SL	
	- 40-mm CS round	TC/SL	
	- Shotgun pellet	TC/SL	
	- Shotgun slug	TC/SL	
	Extra ammunition will be preloaded and carried in vehicles	TC/SL	
Mission Situational Awareness			
	Know and understand mission (task and purpose)	All/PL	
	Review ROE for AO	All/PL	
	Review EOF for mission area	All/PL	
	Read latest intelligence summary (INTSUM) and trends from battalion S2	SL/PL	Provide information to squad
	Plot route and conduct map reconnaissance	SL/PL	
	Conduct risk assessment	SL/PSG	
	Know checkpoints passing along primary and alternate routes	SL/PSG	
	Know casualty collection points along route	SL/PSG	
	Brief squad on order and other information for situational awareness	SL/PSG or PL	
	Map of AO: main supply routes/alternate supply routes, maneuver boundaries, location of units along route	SL/PL	Strip map for route
Miscellaneous			
	Casualty kit filled and pre-positioned at HQ	SL/PSG	Litters, blankets, trauma kits
	Hazardous material (HAZMAT) kits filled and pre-positioned at HQ	SL/PSG	

	Conduct all appropriate rehearsals	SL/PSG	Battle drills and miscellaneous (i.e., rollover)
	Point of contact numbers updated at HQ	SL/PL	Higher HQ, Chaplin, Mental Health

Table 2-1

3. Load plan

The load plan confirms Soldiers have the required equipment for their mission and provides quicker and safer access to gear. Platform teams must develop a load plan and follow the layout. SLs may choose the best plan, share it with the squad, and maintain uniformity in case Soldiers are switched to different vehicles. Below is an example of a load plan:

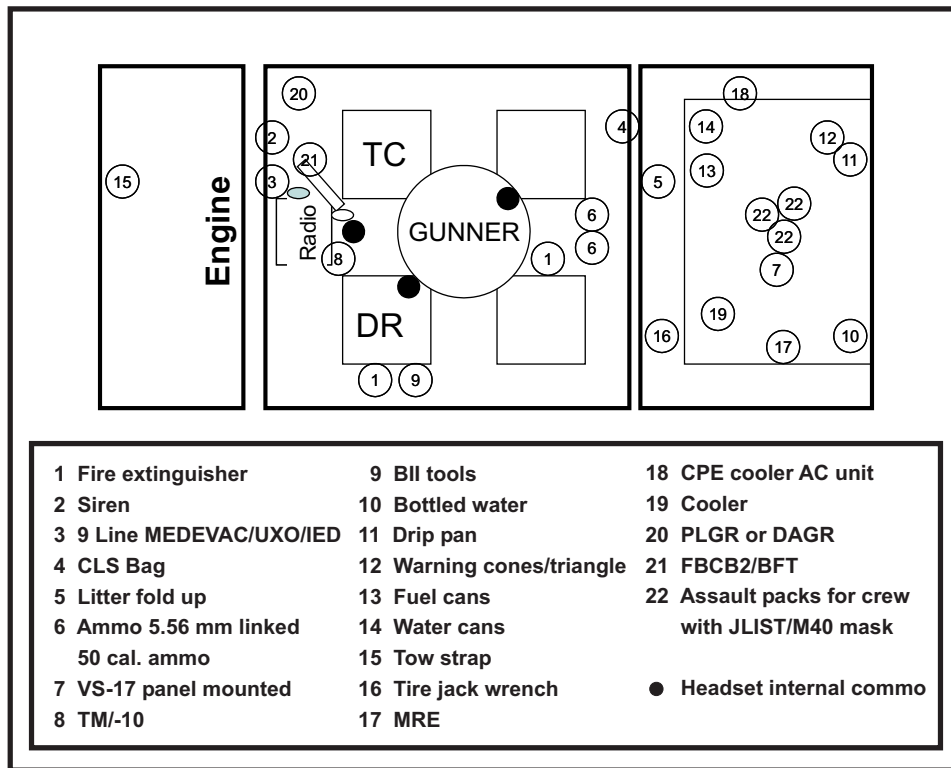

Figure 2-2: Load plan

4. Weapon systems



Figure 2-3: Multiple weapon systems for gunner

Convoys must consider what weapons to employ according to their surroundings, current ROE, and requirements set for EOF. Choosing the right weapon for the given mission helps facilitate success.

a. **M2 .50 caliber machine gun.** The weapon most commonly used in gun trucks for Operation Iraqi Freedom (OIF) is the M2 .50 caliber machine gun.

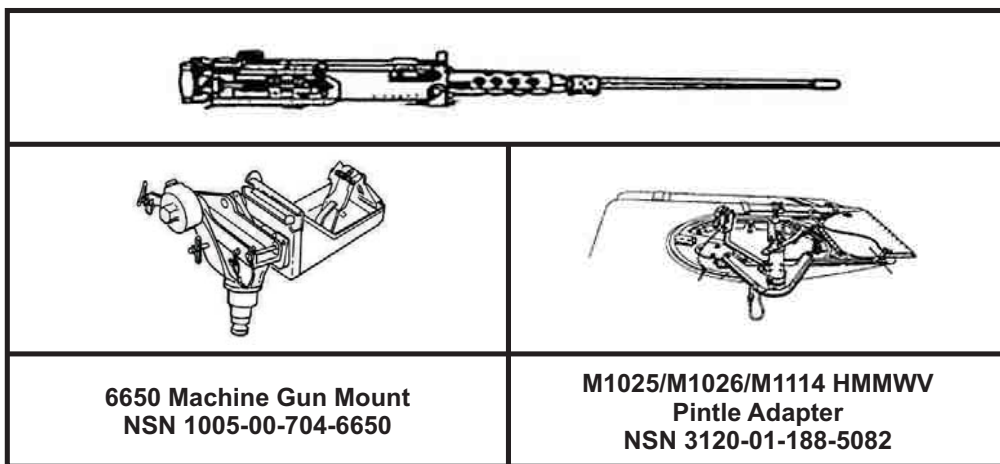
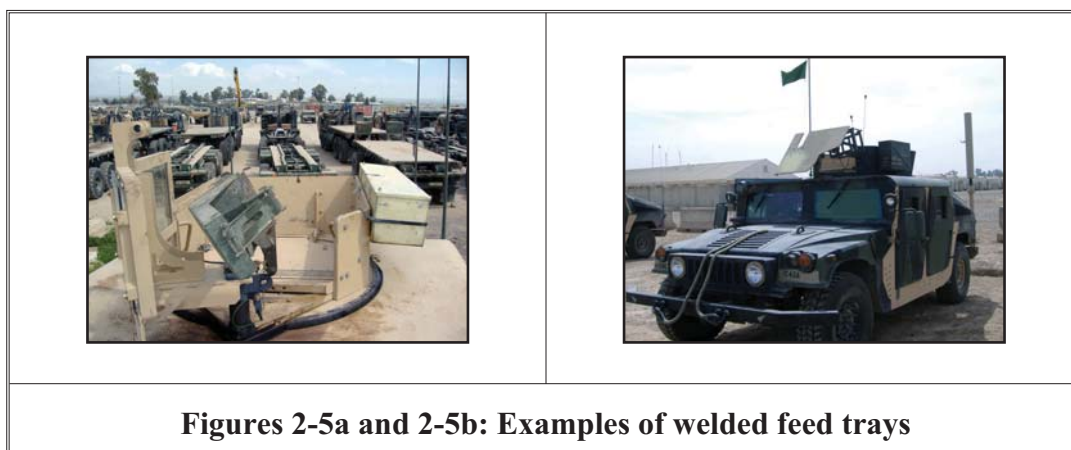

Figure 2-4: M2 .50 caliber machine gun, mount, and adapter

The gunner must verify the proper head space and timing prior to movement. The truck commander should confirm this check prior to departure. If M2s are limited, priority for this weapon location generally goes to the rear and front of the convoy.

The stopping power of the M2 is effective against vehicle-borne improvised explosive devices. Its long range allows convoys to engage an enemy from a long distance and is ideal for routes in the countryside. The local population respects the capabilities of this intimidating weapon. One of the drawbacks of employing the M2 is the increased possibility of collateral damage in urban environments; however, that same effect is useful when engaging an enemy hiding behind walls or other objects.

The basic load for the M2 machine gun is 300 rounds, broken down by 100 linked rounds. The first 100 rounds are placed in the feed tray, the second 100 linked rounds at the ready bracket. (**Note:** Some units find it efficient to weld the feed tray onto the vehicle's armor for quick access). The remaining 100 rounds are secured inside the vehicle in accordance with the load plan.



Gunners must ensure all weapons' PCC and PCI are conducted prior to putting on their CPE.

Some units have reported problems with the M2s they inherited from prior units in theater. One issue concerned the correct M2 mount. Traveling over unimproved alternate supply routes for long distances also tends to clog up the M2 chambers with sand, even with the dust covers closed and causes the weapon system to misfire. Cleaning the system before, during, and after will help minimize this problem. (One unit in theater covers up the weapon except for the trigger with plastic bags while on the move). Refer to Annex B for additional components.

b. M240B machine gun. The M240B is commonly used on gun trucks to provide more fire power than the M249, but less than the M2. Caution must be taken when firing in populated area, as the 7.62-mm range can cause noncombatant casualties at long distances. While this weapon does not have the stopping power of the M2, it is still a powerful weapon with a lesser chance of creating undesired collateral damage.

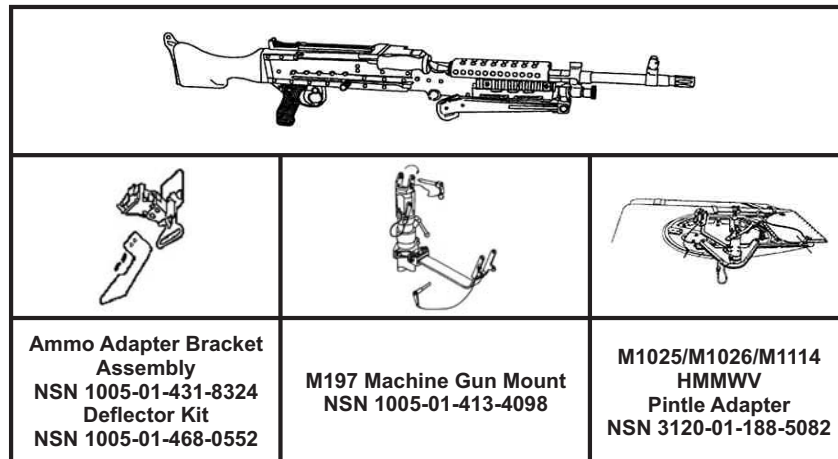

Figure 2-6: M240B machine gun, mount, and adapter

The basic load for the M240 is 600 rounds. 200 rounds are linked and on the feed tray. The remaining 400 rounds are secured inside the vehicle. Refer to Annex C for additional components.

c. **M249 machine gun.** The M249 is a light and very flexible machine gun. The M249 accompanies the M2 or M240B in case additional flexibility is needed. This technique allows the gunner to quickly transition from a heavy machine gun to the much lighter M249. Many units now have a separate mount specifically for the M249 on top of the gunner’s armor shield to facilitate switching weapons.

Depending on the situation, the M249 can also be unmounted to provide additional combat power for fixed site security. An additional advantage to the flexible M249 is its control and ease in stopping runaway belts. The M249 can also be used as the primary weapon for a platform; it is usually complemented by an M16/M4 as its secondary weapon.



Figure 2-7: M249 machine gun, mount, and adapter

The basic load for the M249 is 600 rounds of ammunition. 200 rounds are kept on the feeder tray while the remaining 400 rounds are secured inside the vehicle. Refer to Annex D for further parts or components.

d. **MK19 40-mm grenade machine gun.** The MK19 is primarily used when traveling through open areas and on long-distance missions. Special considerations must be taken to minimize some of the collateral damage when firing the MK19 in populated areas. The gunner must be familiar with the weapon and rehearse actions needed to correct a malfunction on the MK19. This weapon functions best with the Lubricate Sear Assembly (NSN 9150-00-949-9323). Refer to Annex E for additional components.

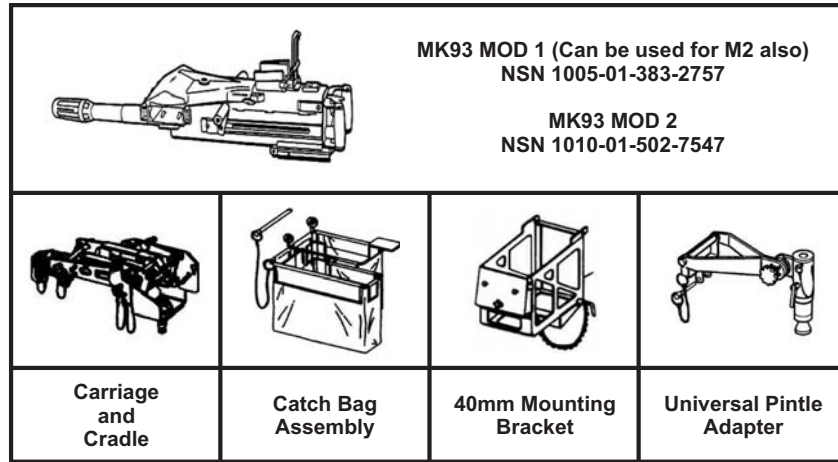

Figure 2-8: MK19 40-mm grenade machine gun and accessories

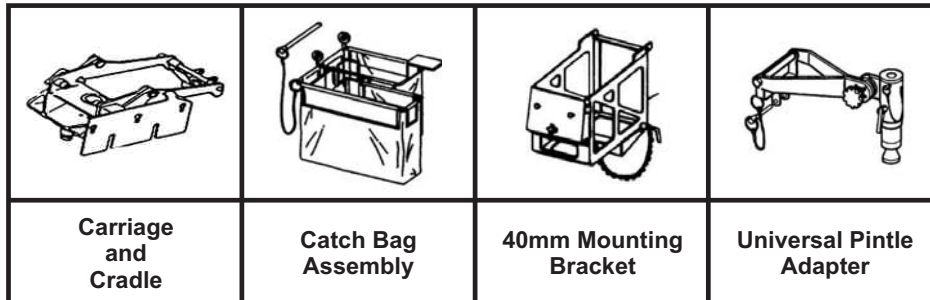

Figure 2-9: MK64 MOD 9

e. **Additional weapons.** In addition to the primary and alternate weapon used by the gunner, personnel may also carry an M9. The M9 provides increase flexibility, especially when driving along areas crowded with civilian population. The M9 allows the ability to point and, if necessary, fire the weapon at targets within inches of the platform. The gunner can also have an M16/M4 as an additional backup weapon. This additional backup weapon can be placed on the left or right side of the compartment inside the wall of the gunner’s armor shields.



Figure 2-10: M9 pistol



Figure 2-11: M4/M16

The driver and TC generally carry both an M4/M16 and M9. The basic load for an M4/M16 is 210 rounds; the basic load for an M9 is 30 rounds. Both the driver and TC must be trained to use these weapons within close quarters marksmanship (CQM) situations. CQM training should be scheduled and conducted as often as possible. A recommended attachment is the close combat optic M68: NSN 1240-01-411-1265; TM 9-1240-413-12&P. This attachment allows a shooter to easily attain the correct site picture to attain appropriate affects. It uses a red dot aiming point and is designed for the two eyes open method of sighting. Ensure the M68 is turned off when not in use.

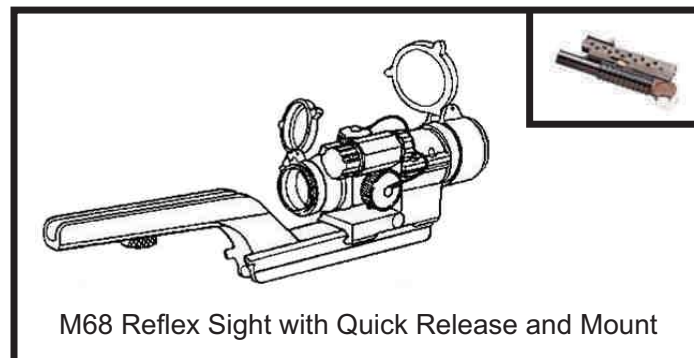

Figure 2-12: M68 reflex sight

An additional squad-level weapon is the M203 attachment. It is recommended that each squad have at least two M203s on different vehicles. The M203's greatest contribution is its arsenal of non-lethal rounds, including the M1029 rubber pellets,

the M1006 sponge round (point), CS gas, and bean-bags. M203 high explosive rounds can assist with multiple enemy targets or targets behind a wall. Illumination rounds can also assist during night operations.

f. Weapons clearing and functions check. A function check must be performed for weapons prior to conducting a mission. Whenever possible, a test fire should be conducted on each weapon. All weapons should be wiped and coated with a light coat of oil or appropriate grease for smooth functioning of the weapon system. Militec grease is thicker than standard cleaner, lubricant, and preservative, and does not attract as much dust, and should be used if possible. Soldiers must also know how to properly clear their assigned weapons. Leader supervision is mandated in most forward operations bases (FOBs).

M2 .50 caliber functions check

Step 1. Place the weapon in the single-shot mode.

Step 2. Open the cover and lock the bolt to the rear (bolt should stay to rear while in the single-shot mode).

Step 3. Hold the retractor handles, press the bolt latch release, and ride the bolt forward.

Step 4. Press down on the trigger; weapon should fire. (Check T-slot to ensure that firing pin does protrude.)

Step 5. Place the weapon in the automatic-fire mode.

Step 6. Pull the retractor slide handle to the rear and hold. (Bolt should not lock to rear.)

Step 7. Release the pressure on the slide handles and ride the bolt forward.

Step 8. Make sure firing pin does not protrude.

Step 9. Press trigger; weapon should fire.

Step 10. Make sure firing pin does protrude.

Note: If weapon is going to be fired after assembly, then the headspace and timing must be set.

M240B functions check

Step 1. Place the safety on “F.”

CENTER FOR ARMY LESSONS LEARNED

Step 2. Pull the cocking handle to the rear, locking the bolt to the rear of the receiver.

Step 3. Return the cocking handle to the forward position.

Step 4. Place the safety on "S," and close the cover.

Step 5. Pull the trigger. (Bolt should not go forward).

Step 6. Place the safety on "F."

Step 7. Pull the cocking handle to the rear, pull the trigger, and ride the bolt forward.

Step 8. Close the ejection port cover.

M249 functions check

Step 1. Grasp the cocking handle with the right hand, palm up, and pull the bolt to the rear, locking it in place.

Step 2. While continuing to hold the resistance on the cocking handle, use the left hand to move the safety to the SAFE position.

Step 3. Push the cocking handle forward into the forward lock position.

Step 4. Pull the trigger (The weapon should not fire).

Step 5. Grasp the cocking handle with the right hand, palm up, and pull and hold it to the rear.

Step 6. Move the safety to the fire position.

Step 7. While continuing to hold resistance on the cocking handle, use the left hand to pull the trigger and ease the bolt forward to prevent it from slamming into the chamber area and damaging the face of the bolt.

Step 8. If the weapon fails the function check, check for missing parts or repeat the reassembly procedures. Before disassembling the weapon, make sure it is positioned where the guide rod and spring cannot cause bodily harm if the bolt is locked to the rear. The cover and feed mechanism assembly can be closed with the bolt in either the forward or the rearward position.

MK19 functions check

Step 1. Close the top cover.

- Step 2. Charge the weapon.
- Step 3. Lock the charging handles forward.
- Step 4. Place the gun on “S” (safe).
- Step 5. Press the trigger.
- Step 6. If the weapon fires, notify the supervisor.
- Step 7. If the weapon does not fire, continue.
- Step 8. Move the safety to “F” (fire).
- Step 9. Press the trigger. Bolt should spring forward.
- Step 10. Open the top cover.
- Step 11. Check the tip of the firing pin. It should be exposed.
- Step 12. Move the feed slide to the left.
- Step 13. Close the top cover.
- Step 14. Move the safety to “S.”

M9 functions check

- Step 1. Clear the pistol in accordance with the unloading procedures.
- Step 2. Depress the slide stop, letting the slide go forward.
- Step 3. Insert an empty magazine into the pistol.
- Step 4. Retract the slide fully and release it. The slide should lock to the rear.
- Step 5. Depress the magazine release button and remove the magazine.
- Step 6. Ensure the decocking/safety lever is in the safe position.
- Step 7. Depress the slide stop. When the slide goes forward, the hammer should fall to the forward position.
- Step 8. Squeeze and release the trigger. The firing pin block should move up and down and the hammer should not move.

Step 9. Place the decocking/safety lever in the fire position.

Step 10. Squeeze trigger to check double action. The hammer should cock and fall.

Step 11. Squeeze the trigger again. Hold it to the rear. Manually retract and release the slide. Release the trigger. A click should be heard and the hammer should not fall.

Step 12. Squeeze the trigger to check the single action. The hammer should fall.

M16A2/M4 carbine rifle functions check

Step 1. Remove magazine and check chamber; be sure to clear the weapon.

Step 2. Place selector lever on safe. Pull charging handle to rear and release. Pull; trigger hammer should not fall.

Step 3. Semi: Place selector lever on semi. Pull trigger; hammer should fall. Hold trigger to the rear and charge the weapon. Release the trigger with a slow, smooth motion, until the trigger is fully forward (an audible click should be heard). Pull trigger; hammer should fall.

Step 4. Burst: Place selector lever on burst. Charge weapon and squeeze trigger; hammer should fall. Hold trigger to the rear; pull charging handle to the rear and release it three times. Release trigger. Squeeze trigger; hammer should fall.

M203 functions check

Step 1. Check the proper operation of the sear. Cock the launcher and pull the trigger. The firing pin should release with a metallic click. Hold the trigger to the rear, and cock the launcher again. Release the trigger, then pull. The firing pin should again release.

Warning: If the sear malfunctions, the launcher could fire without the trigger being pulled.

Step 2. Check the safety in both the safe and fire positions by pulling the trigger. The launcher must be cocked before the safety can be placed in the safe position.

Step 3. Check the leaf sight assembly windage adjustment screw for proper operation. Move the elevation adjustment screw only if the weapon has been zeroed.

Step 4. Move the barrel forward and back, to be sure both the stop and barrel latch function.

5. Communications

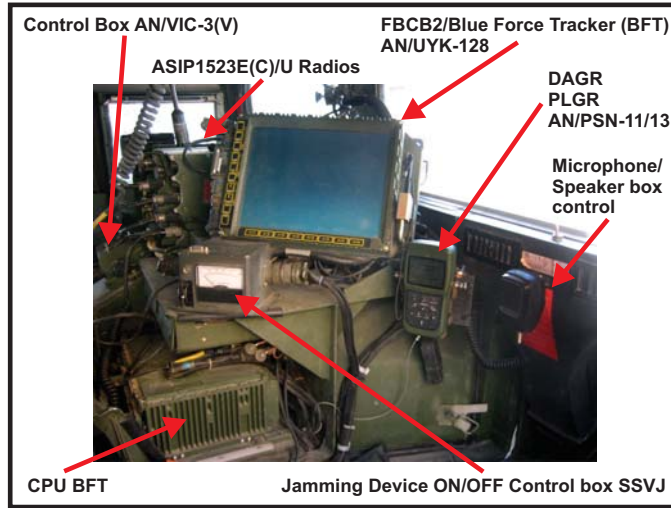

Figure 2-13: Communication systems

Prior to leaving for any mission, the SL must ensure communication systems are functioning and redundancy exists. All Soldiers must be proficient in initializing and programming each system. The primary communication means is the Single-Channel Ground and Airborne Radio System (SINCGARS) or ASIP SINCGARS. Platforms use the Vehicle Internal Communications (VIC) system headset known as the AN/VIC-3(V) (TM 11-5830-263-10; TM 11-5830-340-23P) to complement ASIP SINCGARS. The secondary means of communication is FBCB2, otherwise known as BFT, or the MTS. Another method is the cell phone. Internal to the squad, the secure integrated communication (ICOM) radios, hand and arm signals, and light signals can also be used for degraded operations.



Ground SIP



Figures 2-14a and 2-14b: Single-Channel Ground and Airborne Radio System

a. **SINCGARS/ASIP.** SINCGARS/ASIP is the primary internal and external method of communications at the squad level. All vehicles should have two radios. One radio monitors the internal network (net); the other monitors either HQ or the

appropriate landowner as they pass through the battlespace. Each radio should be pre-programmed for the frequencies of landowners the convoy passes. As the convoy enters each landowner's battlespace, the convoy commander (or assistant convoy commander) conducts a communications check and lets the landowner know the convoy's composition and how long the convoy expects to be in the area of operations. Additionally, the sheriff's net and 9-line MEDEVAC nets should be programmed on the radios. Generally different platforms, other than the convoy commander's, will monitor special nets (sheriff, quick reaction force [QRF] etc.) in lieu of higher HQ or landowner nets.

Troubleshooting

1. Check radio's COMSEC, function, power, and mode switches to verify they are correct.
2. Check radio's antenna connection and power amp if it applies; make sure connections are not loose.
3. Make sure unit is operating on the correct frequency.
4. Verify time on radio by using the PLGR as a reference. **Note:** By checking time, you are making sure the Julian date, hours, minutes, and seconds are correct.
5. After checking equipment, get radio checks from battalion or other element in the operation to verify communications.

Loading SINCGARS with automated net control device (ANCD):

1. Turn on ANCD and SINCGARS radio.
2. Set SINCGARS radio up to load COMSEC keys and FH data:
 - COMSEC to CT
 - FCTN to LD
 - MODE to FH
 - CHAN to MAN
 - DATA to OFF
3. Select: RADIO on ANCD, and press ENTER.
4. Select: SEND, and press ENTER.

5. Select: RADIO, and press ENTER.
6. Select: ICOM, and press ENTER.
7. Connect to receiver-transmitter (RT) AUD/Fill connector using the (W4) fill cable.
8. Set FCTN control knob on radio to LD.
9. Display will show: Do you want to include TIME? Y/N? ENTER“N” for no.
Note: Time must be entered manually. The RT is not set up to receive the clock from the ANCD; however, for an accurate time you can use the PLGR to load the time into the RT.
10. Press LOAD on radio.
- 11 Display screen on ANCD will show: TRANSFER IN PROGRESS; then: ICOM TRANSFER SUCCESSFUL.

Change Net ID

1. Set FCTN to LD, and select channel you want changed.
2. Press FREQ, display shows [FXXX].
3. Press CLR, display shows [F___].
4. Enter ID numbers, display shows numbers entered.
5. Press STO; display blinks; new NET ID is stored.
6. Set FCTN to SQ ON; new NET ID is available for use.

* The ASIP radio allows a change of all three digits of a net ID with the MODE switch set to FH or FH-M.

Change Julian date

1. Set FCTN to LD.
2. Press TIME, display shows “DD.”
3. Press CLR, display shows “_ _”.
4. Enter Julian date.

5. Press STO; Julian date loaded into RT.

The pocket guide for SINCGARS is TM 11-5820-890-10-6.

b. Vehicle intercommunication system (VIS). The VIS headset known as the AN/VIC-3(V) (TM 11-5830-263-10) is used inside the platform to enhance SINCGAR/ASIP communication. If this system is available, Soldiers should be trained to use it. This system minimizes the effects of outside noises and allows a team to communicate without raising their voices. The system is used for both internal communications (inside the platform, to include the gunner and throughout the convoy), as well as with outside agencies (such as HQ and landowners).

This system is more flexible than the combat vehicle crew helmet and allows Soldiers to keep protective headgear on when leaving the vehicle. VIS enables the user to key and transmit on the radio regardless of the position in a two-position toggle switch.

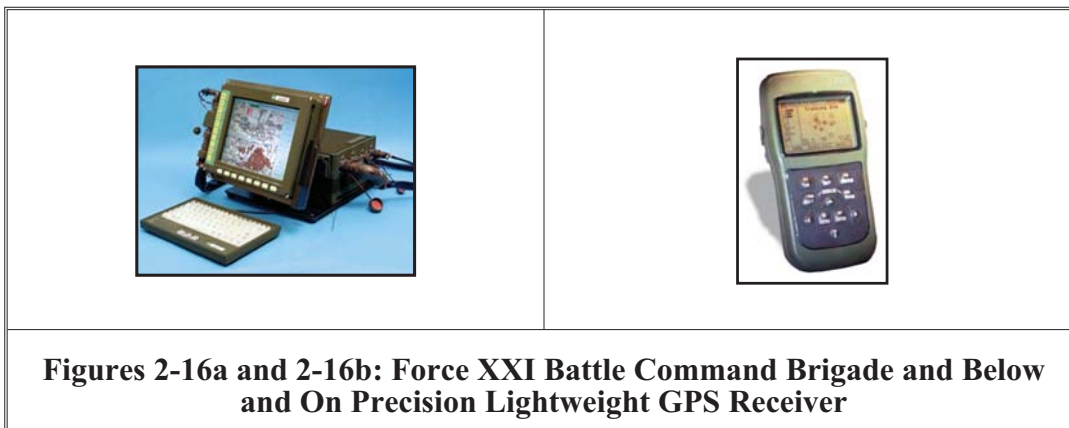

Figure 2-15: Vehicle Intercommunication System

c. FBCB2/BFT. The secondary means of communication (if available) is FBCB2, otherwise known as BFT, (TM 11-7010-326-10-1). This system allows TCs to send typed messages to other FBCB2 units via the wide area networks; upgraded systems use satellites to send digital traffic. Users can send certain reports via FBCB2 digital messaging. In addition to digital communication, the FBCB2 system assists with navigation.

When properly connected with a PLGR or DAGR, and if functioning properly, the platform is displayed in the form of a blue circle and placed on top of a digital map on its current location. Requesting graphics from higher HQ, or creating unit graphics, also assists in navigating from point to point.

Note: While FBCB2 is a great navigational tool, it does not replace the need for basic map reading skills. Soldiers may not always have the FBCB2 available.



d. **MTS.** The Army has adapted technology to transform its logistics systems through the development and installation of the MTS. MTS is a satellite-based tracking and communication system. Through military GPS and two-way messaging, MTS provides worldwide coverage and positive tracking of movements. Since it does not depend on existing landlines, MTS is a more secure system, less vulnerable to interruptions.

MTS gives users the ability to identify positions of MTS-equipped tactical vehicles, track their progress, and send messages back and forth. The MTS messaging capability has a database of addresses for all MTS-equipped platforms in a group; however, messages are limited to 100 characters. MTS provides an “in-the-truck” compact computer screen that displays a rolling map. The map is designed to let operators know exactly where they are at all times by routinely updating maps from the National Geospatial-Intelligence Agency and uploading the maps into the MTS, based on a unit’s mission and expected areas of deployment.



Figure 2-17: Movement Tracking System

e. Alternate means of communication

- **Cell phones.** Since the distances of some convoys are beyond the range of SINCGARS/ASIP and not every convoy has BFT or MTS, cell phones that can attain a signal can assist in communications. The best case scenario is having a satellite phone; however, a cell phone will cover most areas along common routes.
- **ICOM radios.** These short-range radios can be used as backups if primary communications fails.

- **Visual communication.** As a last resort, squads should develop hand and arm signal TTP for day and light signals for night in case other communications systems fail. Below are some examples of visual signals:

- **Mount.** Extend one arm up and to the side. Make two or three arm movements up and down with palm facing upward.



Figure 2-18: Mount signal

- **Dismount.** Extend the arms. Make two or three movements up and down with hands open towards the ground.



Figure 2-19: Dismount signal

- **Join me, Follow me, or Come forward.** Point toward person(s) or units(s). Beckon by holding the arm horizontally to the front, palm up, and motioning toward your body.



Figure 2-20: Join me, Follow me, or Come forward signal

- **Assemble or Rally.** Raise the arm vertically overhead, palm to the front, and wave in large, horizontal circles. This signal is normally followed by the signaler pointing to the assembly or rally site.



Figure 2-21: Assemble or rally signal

- **Move forward (casualty evacuation [CASEVAC]).** This is a two-part signal. First, raise both arms and cross wrists above the head, palms to the front. Second, move the hands and forearms backward and forward, palms toward the chest.



Figure 2-22: Move forward signal (CASEVAC)

- **Move forward (recovery).** This is a two-part signal. First, extend the arm and fist toward the operator, thumb pointing up. Second, move the hands and forearms backward and forward, palms toward the chest.



Figure 2-23: Move forward signal (recovery)

- **I am ready, Ready to move, or Are you ready?** Extend the arm toward the person being signaled, then raise the arm slightly above horizontal, palm outward.



Figure 2-24: I am ready, Ready to move, or Are you ready? signal

- **Attention.** Extend arm sideways, slightly above the horizontal; palm to the front; wave arm to and from the head several times.



Figure 2-25: Attention signal

- **Start engine or Prepare to move.** Day: Simulate cranking of engines by moving the arm, with the fist, in a circular motion at waist level. Night: Move a light to describe a horizontal figure 8 in a vertical plane in front of the body.



Figure 2-26: Start engine or Prepare to move signal

- **Move in reverse** (for stationary vehicles). Day: Face the vehicle(s) (unit) being signaled, raise the hands to shoulder level, palms to the front. Move the hands forward and backward. Night: Hold a light at shoulder level; blink it several times toward vehicle(s).

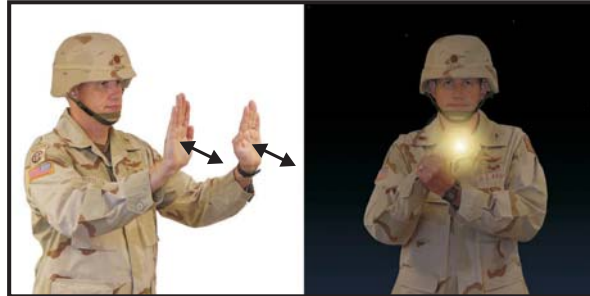

Figure 2-27: Move in reverse signal, day and night (for stationary vehicles)

- **Button Up and Unbutton**. Place both hands, one on top of the other, palms down, on top of the helmet. The arms are back and in the same plane as the body. For Unbutton, give Button Up signal, then separate the hands, moving them to each side in a slicing motion; repeat.

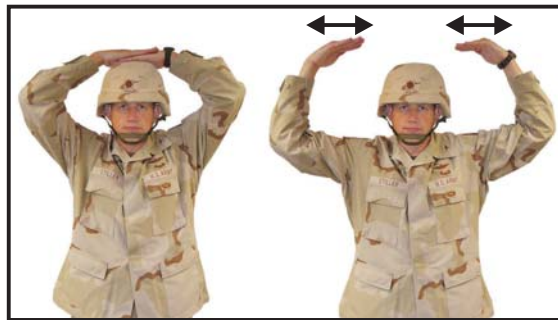

Figure 2-28: Button Up and Unbutton signals

- **Right or left turn**. Day: Extend the arm horizontally to the side, palm outward. Night: Rotate a light to describe a circle 12 to 18 inches in diameter in the direction of the turn.



Figure 2-29: Right or left turn signal, day and night

f. Communication PMCS

All communication and digital devices should go through routine PMCS and a thorough service program to identify problems prior to and after mission execution. A dedicated military occupation specialty-trained communications noncommissioned officer with training in both the BFT and counter IED device systems will greatly enhance your communications capability. Soldiers should also understand how digital devices affect communications systems. Most versions of electronic countermeasure jamming devices will jam all friendly communications within range.

6. Rehearsals

Conducting rehearsals before each mission is essential to mission success and the safety of Soldiers. Rehearsals use TTP/battle drills to identify missing and defective equipment and other deficiencies. Rehearsals can be conducted in various ways and should involve Soldiers and civilians acting within their specific roles on the convoy. Rehearsals should be tailored to the mission. Following are some battle drills that require frequent rehearsals (convoys should not limit themselves to this list):

- Vehicle recovery
- Self CASEVAC
- Rollover drills
- 9-line MEDEVAC request
- React to contact with the enemy
- React to exploded/unexploded IED
- IED/UXO report
- EOF situations
- Gunner down drills
- Actions on objective
- ROE
- EOF/RUF
- All battle drills
- Contingency communication drills

Rehearsals conducted using real world situations will decrease damage to equipment, injuries, and fatalities. When conducting rehearsals, duties and responsibilities should be rotated to ensure that each Soldier is cross-trained and knows everyone else’s job. Rehearsals should be conducted using the crawl-walk-run method to ensure Soldiers’ complete understanding of what actions to take in various situations. After-actions reviews should be conducted after each rehearsal to address any shortcomings and verify each Soldier knows their duty.

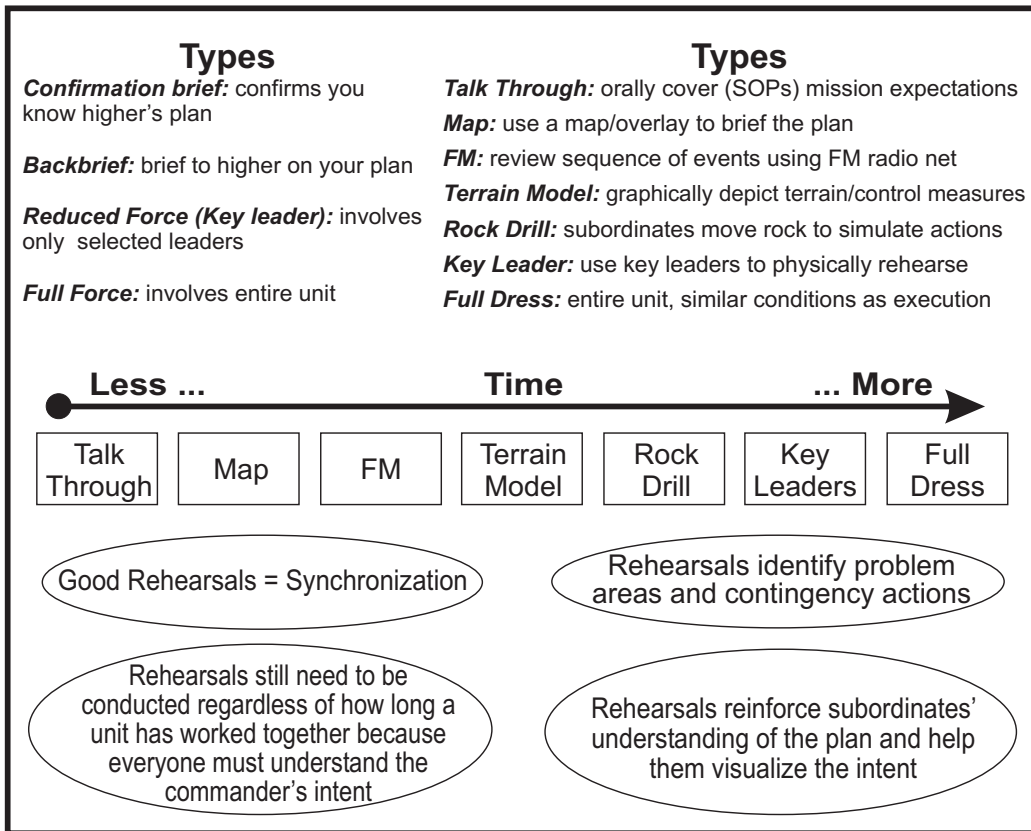

Figure 2-30: Sample rehearsal timeline

7. Common vehicle maintenance issues

Maintenance is conducted to identify, mitigate, and if possible, prevent mechanical problems that could disrupt combat operations. The conditions in Iraq require intense focus on military equipment maintenance. Most roads in Iraq are unpaved, adding to the wear and tear on the heavy M1114 and other vehicles. Roads that are paved are inundated with potholes. The fine dust particles are easily absorbed into equipment crevices, setting up conditions for future mechanical failure. In addition, the operating environment routine damages equipment. Knowing maintenance procedures and emphasizing maintenance helps ensure a healthy unit operational readiness rate.

Here are some common maintenance issues identified in support of OIF:

- Most mechanics and users are not familiar with the M1114. While the M1114 is similar to the M1025 and M998, there are critical differences. Units must make an effort to schedule M1114 formal maintenance training for their mechanics. Units should send all Soldiers to M1114 familiarization training (including obstacle and emergency training).
- Because of the weight of the M1114, brake pads wear completely down and must be replaced monthly. Brake pads should be added to the command directed prescribed load listing (PLL).
- The heat, poor road conditions, added weight, and numerous missions increase the wear and tear on tires. Rotate tires once every two months (FL to RR, FR to RL). The life expectancy of tires is about four months for most security force units. Units replace tires up to three times a year per platform. Adding M1114 tires to the command-directed PLL assists in having spare tires available for exchange (TM 9-2320-387-10/20). Certain exceptions are made for specially-designed tires.
- Due to the vehicle's weight, the power steering pump (PSP) also tends to deteriorate. The life expectancy for security force PSPs is about three months.
- Because of continuous air conditioning (AC) use during operations with the open turret, the air is not being recycled to keep the compartment cool enough to shut off the thermostat. The constant working of the AC unit causes the compressor to wear down quickly. Even if the AC unit is still under warranty, it could take contractors 48 hours to replace it. Once the warranty expires, it may take longer to fix. One technique is to recharge the AC system by sealing the vehicle and turning on the AC for an hour to recycle the air in the compartment. Cleaning out the air filters frequently and changing them out monthly helps mitigate the breakdown of the AC unit.
- The suspension system of the M1114 is constantly worn due to the weight of the armor, unimproved road conditions, and the numerous miles put on the platform. Regularly look for tears in ball joints to prevent bigger problems. Most mechanics replace half-shaft bolts under the M1114 regularly (monthly) due to the weight and excess vibration.
- Tighten lug nuts weekly.
- Regularly check the bolts mounting the generator bracket. Bolts tend to shear off due to the excess vibration and extended convoys.
- The M1114 (or equivalent gun-truck) is a pacing item for security forces in theater. If possible, a float M1114 can assist in providing the number of platforms needed for a mission. When an M1114 goes down, ensure the team assists the mechanic in getting the vehicle mission-capable. In general, when a pacing item goes down, the crew and mechanics should work around the clock to get the vehicle up. **Note:** See Annex F for an example of a Quality assurance/quality control checklist.

8. Mission brief

The mission brief is conducted either in the operations center or appropriate briefing room with the necessary charts, maps, and tools to effectively depict the information detrimental to mission success. The mission is sent from battalion to the company in the form of a fragmentary order (FRAGO) and is analyzed by the company HQ. A platoon is then selected for the mission, who will, in turn, task a squad. Depending on the type of mission and current personnel status, the PL may select one squad or task organize teams within the platoon to make a larger security force unit for the convoy. The squad starts troop leading procedures (TLP) once it receives the mission, normally 48 hours prior to start point (SP).

1. Receive the mission
2. Issue warning order
3. Make tentative plan
4. Initiate necessary movement
5. Conduct reconnaissance
6. Complete the plan
7. Issue orders
8. Supervise and refine

The SL receives his order from the operations sergeant, who will also receive the SL's backbrief in the presence of the PL and the commander. In addition to the conducting the backbrief, prior to movement, the SL turns in all required documents such as the convoy manifest and PCC/PCI checklists. The SL also receives the latest significant activities (SIGACTs), intelligence briefs, updated information on road conditions, and the latest enemy TTP. The SL assembles his squad in the briefing room and conducts his convoy brief with special emphasis on any changes to the FRAGO and adjustments needed. The brief is done in front of a map or projection screen using digital representations to show the squad the exact road networks and key points of interest that will be on the route.

The mission brief generally follows the standard five paragraph OPORD format. Below is an example of the type of information found in the OPORD and/or FRAGO:

Situation. The situation is segmented into four paragraphs: enemy situation, SIGACTS, friendly forces, and weather.

- **Enemy situation.** Describes the enemy's composition, current location, equipment, and tactics and employment.
- **SIGACTS.** Describes any pertinent information within the last 72 hours that occurred along the proposed route. SIGACTs assist in forming trends that could either hinder or aid in mission accomplishment.
- **Friendly forces.** Describes the forces and landowners in the battlespace. Friendly force information also assists in the planning phase by identifying available assets along the route.
- **Weather.** Weather data from the meteorological office, normally manned by the Air Force meteorologist or online weather services. Weather data provides information on first light and twilight, lunar illumination, expected precipitation, and temperature.

Mission. Mission describes the what, when, who, where, and why of the mission.

Execution. Execution should consist of at least the following three sub-paragraphs:

- **Concept of operations.** Describes the mission and the general scheme, timeline, and agencies involved.
- **Tasks to subordinate units.** Covers additional tasks to subordinate units not covered in the SOP. This paragraph is extremely important when working with agencies outside of your organization.
- **Coordinating instructions.** Lists coordinating measures (i.e., meeting times, SP, frequencies, etc.).

Service and support. Any special support requirements outside of the unit SOP are listed in this paragraph. Ensure you know the location and frequencies of available assistance along the mission route.

Command and signal. Look for frequencies of landowners along your mission route.

9. Convoy brief

A convoy brief is given by the SL to his squad members, in addition to any other members of the convoy (such as Kellogg, Brown, and Root, Iraqi national truck drivers, interpreters, etc.) and is done anywhere from one to two hours prior to execution of the mission. The brief is normally conducted in a briefing room with digital representations displayed through a projector or using the appropriate map. The SL will verbally brief the five-paragraph convoy OPORD to the squad, and immediately following the briefing, the squad will converge around an appropriate map or strip map.

There are various methods used in conducting a briefing. The map method is used when there is minimal time and space. During this time, strip maps that include frequencies for landowners should be passed out to all convoy TCs, including non-military personnel. Time permitting, non-military personnel should also rehearse their appropriate actions given the common enemy activities within the operational environment. The SL must be prepared to communicate with non-English-speaking TCs and drivers.

Upon completion of the convoy brief, the SL should receive brief-backs from his TCs. TCs should also receive brief-backs from their teams. The convoy commander must take great effort to incorporate methods that mitigate complacency within continuous routine missions. Remind Soldiers that every mission is serious.

10. Convoy manifest

A convoy manifest is an administrative tool used to ensure convoy requirements are completed. This tool also assists in the conduct of contingency missions if contact with the enemy is made. The tool's basic function is to provide higher HQ situational awareness, identifying who is out with each piece of equipment and defining the expected duration of the mission.

The convoy commander is responsible for the timely completion and accuracy of information of the convoy manifest. The convoy manifest process should begin upon receipt of the mission and will be turned into the battalion tactical operations center (via company HQ) no later than 24 hours prior to movement. Convoy manifests differ from FOB to FOB; each has its own SOP. Once complete, the convoy manifest is considered classified. Generally a convoy manifest consists of the following:

- Name of convoy commander and the assistant.
- Radio call signs.
- SP point, destination, and release points.
- Names, battle roster numbers, and blood types of all personnel in convoy.
- Weapons systems by type and serial number and where they are placed within the convoy.
- Order of march by bumper number and locations of special teams (recovery and aid and litter).
- Types of vehicles.
- Location of special equipment (FBCB2, electronic countermeasure systems).

CENTER FOR ARMY LESSONS LEARNED

CONVOY MANIFEST

TMR#: 589SB-031	TASKED UNIT			OFFICERS		ENLISTED		PRIME MOVERS		WEAPONS		
589TH BSB A CO	HHC			CW1		CSM		M1078/83-ORG	3MM		1	
	A CO	12		CW2		1SG		M1078/83-GT	M16 / M4		13	
	B CO	3		CW3		MSG		M1114	M203			
	B1/377	4		CW4		SFC	1	M1075 BOBTAIL	M249		6	
ORIGIN: SEINERTY	TOTAL	19		CW5		SSG	2	M1075/76 SYS	M60			
DEST: Rustamiyah			2LT		SGT	4	M1070 BOBTAIL	M240B				
			1LT		CPL	1	M1070 SYS	M2			5	
			CPT		SPC	3	KBR	12	MK19			
DTG OF MISSION	26-Feb-06			MAJ		PFC	8	PWC	TOTAL		25	
TYPE OF MISSION	CL IX SECURITY			LTC		PVT		TOTAL	17	COMMO		
SP TIME / LOCATION	0001 / ECP 1			COL		PVT		WRECKER		SINGARS		
			GEN		TOTAL	TOTAL	19	M984		FBCB2 / BFT	5	
			TOTAL	0				M1089		MTS		
PRIMARY ROUTE:	IRISH-OILERS-WILD-PREDATORS-BREWERS-PLUTO								TOTAL VEHICLES	17	CLS	
ALT ROUTE:	IRISH-SENATORS-PREDATORS-BREWERS-PLUTO								TOTAL		TOTAL	14
FREQUENCIES: BN - FH/CT 123 SHERIFF - SC/PT 12.345 CONVOY - SC/CT 12.346												
UNIT	PRIMARY VEHICLE & BUMPER #	RANK	NAME / BATTLE ROSTER NUMBER	BLOOD TYPE	WEAPON ADMIN NUMBER	WEAPON SERIAL NUMBER	WEAPON	MOUNTED WEAPON	CLS	CALL SIGN	MTS / ROLE	
ACO	CC	SSG	WEEKS, VERONICA MW0485	O+		7388009	M16			RIDER 4	FBCB2	
ACO		SPC	Last, First NN4492	A+		056966	M249		Y		PL-GEN-SPLY-A-589SB	
ACO	M1114	PFC	Last, First KB0808	O-		7008505	M16	3003760/M2	Y		WARLOCK	
B1/377	A26	SFC	Last, First	O+	B240	W176097	M4/M9				ICE	
ACO	ACC	SSG	Last, First RS8801	O+		10007303	M16		Y	RIDER 3	FBCB2	
ACO		PFC	Last, First S0182	B+		008221	M16	1671308	Y		FUEL-A-589SB	
ACO	M1114	PFC	Last, First OC 4819	O+		106809	M249		Y		WARLOCK	
B1/377	A36	SGT	Last, First 3718	A+	B225	W177193	M4/M9		Y		ICE	
ACO		SGT	Last, First JP5279	O+		7387770	M16		Y	RIDER 2	FBCB2	
ACO		PFC	Last, First KT9871	A+		007472	M249	1671303/M2	Y		CDR-A-589	
ACO	M1114	SPC	Last, First VP0454	O+		1007511	M16		Y		WARLOCK	
B1/377	A6	SPC	Last, First 2927	A-	B228	W176612	M4				ICE	
ACO		SGT	Last, First CS5380	A+		10007843	M16			RIDER 1	IFT	
ACO		PFC	Last, First SM7199	A+		0.0168	M249		Y		MOBILE1-DIVARTY-3ID	
ACO	M1114	PFC	Last, First BS0352	A+		135773	M249	5001545/M2	Y		WARLOCK	
B1/377	A17	CPL	Last, First	O+	B227	W177869	M4				ICE	
BCO		SGT	Last, First MR6546	B+		7008019	M16	M2	Y	BANDIT 9	FBCB2	
BCO		PFC	Last, First DB5969	O+		136003	M249		Y		MNT-CNTRL-SEC-B-589SB	
BCO	M1114	PFC	Last, First MP1133	B-		7028021	M16		Y		WARLOCK	
	B9										ICE	

Convoy manifest must be filled out in its entirety. SPOT Team is responsible for the top half. Company and/or S3 is responsible for the bottom half. SPOT Team will verify with the CC at the PCC/PCI and rehearsals. Changes are after N -36 require BC approval.

Figure 2-31: Sample convoy manifest

Chapter 3

During Operations

1. Duties and Responsibilities

a. **Squad leader (SL)/Convoy commander (CC).** The SL/CC's vehicle is located in the best position to command and control the size of the convoy; generally its position within a convoy is changed after each mission to prevent patterns from developing. SL/CCs must have communications with the entire convoy as well as the reportable headquarters (HQ). SL/CC's duties and responsibilities include the following:

- Operates, updates, and tracks digital navigation devices (i.e., AN/UYK-128, Force XXI battle command brigade and below [FBCB2] [Blue Force Tracker (BFT)], AN/PSN-11 Precision Lightweight Global Positioning System [GPS] Receiver [PLGR], AN/PSN-13 Defense Advanced GPS Receiver [DAGR], Movement Tracking System [MTS], etc.) and sends appropriate reports using this equipment to higher HQ.
- Sends size, activity, location, unit, time, and equipment (SALUTE) report and serious incident reports immediately to higher headquarters.
- Sends SALUTE report and serious incident reports immediately to higher headquarters if an incident happens while the convoy is out on a mission.
- Establishes communication with landowners while the convoy moves from one sector to the next.
- Tracks and reports designated checkpoints.
- Uses a siren to guide civilian traffic out of the way.
- Makes on-the-spot decisions on how to engage and destroy enemy in contact with the convoy.

b. **Truck commander (TC)/Team leader.** TC/Team leader duties and responsibilities include the following:

- Remains in constant communication with crew and CC.
- Looks for indicators of improvised explosive devices (IEDs).
- Observes the actions of the civilians in the local area.
- Monitors intervals between front and rear trucks.
- Maintains situational awareness; moves platform to appropriate blocking positions along route (as necessary) with coordination from the CC.
- Monitors digital updates via BFT or MTS.

- Checks that vehicles are “battle locked” as appropriate.
- Ensures “5-25” meter scans are conducted at every halt.

c. Gunner. Gunner duties and responsibilities include the following:

- Aggressively scans surroundings and reports any significant observations to the TC.
- Maintains positive control of weapon and muzzle awareness.
- Periodically speaks to crew inside the vehicle to check the operation of the internal communication system.
- Immediately trains weapon on any threat and informs crew of what is happening (provides the distance, direction, description [3Ds]), so they can immediately record date-time-group (DTG) and grid to assist the TC in making his initial contact report to the CC.
- Determines which weapon system is most appropriate for hostile situations; gunner must also internalize the rules for escalation of force (EOF).
- Must be prepared to submerge inside the vehicle when passing under an overpass, while still scanning the overpass for enemy activity.
- Gets attention of civilians walking on or near the convoy to alert them to move away from the road. Gives the convoy a safety zone away from pedestrians in crowded areas.
- Positively identifies threats. Seeks and destroys the enemy as necessary.
- Conducts “5-25” meter scans at every halt.
- Reloads weapons as necessary.

d. Driver. Driver duties and responsibilities include the following:

- Focuses on safely driving the assigned vehicle.
- Maintains convoy interval (mission-dictated).
- Constantly looks for indicators of IEDs.
- Constantly monitors vehicle gauges for normal operation; informs TC of any vehicle abnormalities.
- Assists the TC in monitoring radio frequencies.
- Serves as the alternate navigator; driver must know the designated route.

- Conducts preventive maintenance checks and services (PMCS) during operations, as time permits.
- Gathers information to complete SF 91, Motor Vehicle Accident Report, if involved in an accident.

2. Mission Considerations

a. Personal security detachment (PSD)

- Does very important person (VIP) have a personal vehicle? If not, where does VIP want to go?
- What are the actions with VIP if contact is made with the enemy?
- Will unit have to conduct fixed site security for the VIP?
- Does the VIP or destination have its own security (civilian or military)?
- What communication devices will be used with VIP?
- Who will escort the VIP while in military control?
- Who will escort the interpreter, and how is the interpreter utilized?
- What types of electronic countermeasures are incorporated with civilian vehicles?
- What is the VIP's timeline?
- Who is receiving the VIP?

b. Convoy security

- What is the maneuverability of civilian vehicles (i.e. Kellogg, Brown, and Root trucks)?
- What are the recovery assets available for civilian vehicles?
- Will the civilian convoy take additional trucks, without trailers, in case trucks break down during the mission?
- How many vehicles are included in the convoy?
- Is there a proper gun truck to civilian vehicle ratio?
- How does speed affect civilian vehicles (truck's weight versus speed)?
- Does unit need rehearsal and briefing time with civilian TCs and drivers?
- Can the civilian drivers speak English?
- What is the communication procedure with civilian TCs?

c. **Enemy implementation of IEDs.** IEDs and vehicle-borne improvised explosive devices (VBIEDs) are currently the greatest threats to coalition forces in theater. Threat forces have turned to the employment of IEDs as the primary method of attack. This technique provides the threat a standoff capability for the initiation, facilitating a quick and distant escape from the kill zone. Some of these attacks include the use of direct fire weapons immediately following or prior to the detonation of an IED. Training should be scheduled frequently to update all personnel on the current IED threat. Unexploded ordnance (UXO) should be treated in the same manner as IEDs. All personnel in a convoy must be alert for camouflaged IEDs in their sector of scan.

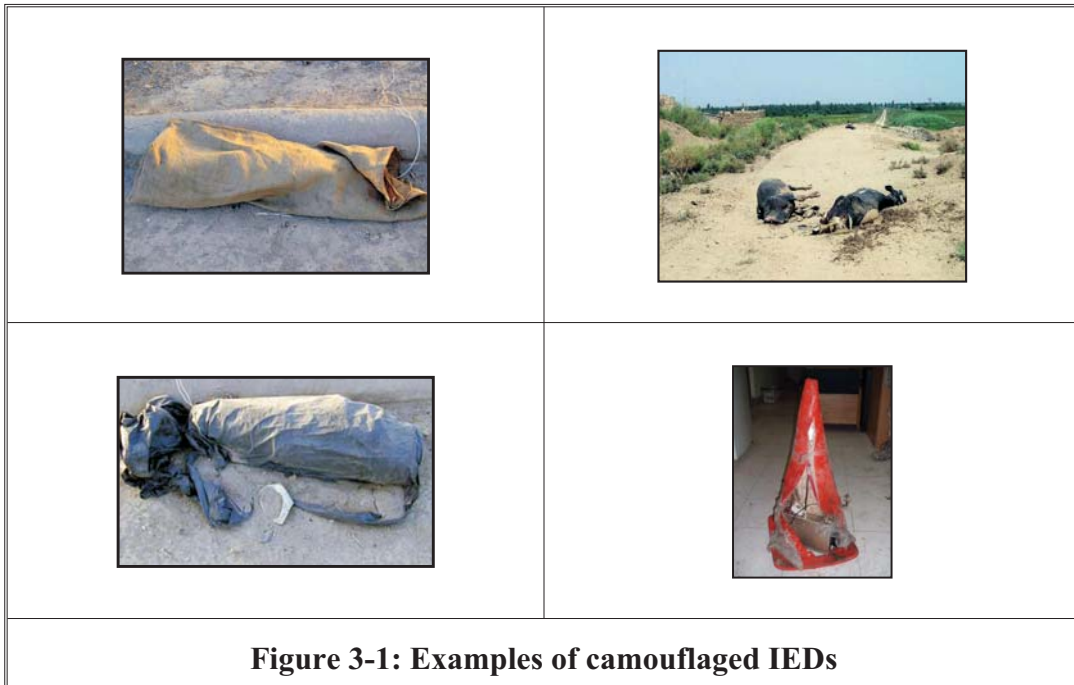

d. **IED trends:**

- IEDs are most often designed to be command detonated by either a hardwired system (speaker wire, red detonation cord, yellow wire with blasting caps) or a remote controlled system (car alarm, cell phone, garage door opener, cordless phone, Motorola radio).
- IEDs are normally designed using mortar rounds, artillery projectiles, plastics, TNT, and other explosive-filled ordnance. These explosives typically already have a method to produce fragmentation.
- Locations for the enemy to command detonate are often within line of sight (usually 150 to 200 meters away).
- IED camouflaging typically has been with items that resemble the garbage along roadways, broken-down vehicles, roadside containers, dirt mounds, and tires. IEDs are elevated behind road signs and hidden in trees or other items that appear to be normal.

- IED emplacement has been located under the paving stones either on walkways or road systems. These devices can also be buried in potholes or in the unimproved road surfaces.
- The enemy has been known to use obvious decoy devices (bait device) out in the open to slow or stop convoys in the targeted zone where the actual device is hidden or ambush is planned. Multiple IEDs are often emplaced in one general location.



Figure 3-2: IEDs vary in form and location

- IEDs and other devices have been deployed from overpasses. Typically these devices are either thrown by personnel or swung down or hung from measured ropes to target strike at windshield/operator level. Trip wires have also been used, and piano wire has been used to decapitate gunners.
- Individuals of all ages, both male and female, have employed IEDs.
- The majority of IEDs are placed during darkness to limit the chance of the individual being seen or confronted while emplacing the device.
- IEDs are often employed prior to first light.
- Maintain a standoff distance of at least 300 meters from suspected IEDs/UXO, as communication devices may cause detonation or enemy personnel may have the ability to remotely command detonate.
- The enemy has begun to burn vehicle tires on asphalt roads to loosen the asphalt for emplacement of IEDs underneath the road surface. The IED then resembles a patch in the road.
- IEDs are now being executed followed by small arms ambush or rocket propelled grenade attack; this is a complex ambush and may come from both sides of the convoy.
- The enemy has put ball bearings into IEDs to achieve more fragmentation. They also place soap chips in IEDs with fuel so when it explodes, it sticks and burns the skin.
- The latest IEDs include explosively formed projectiles. See your S2 for methods (classified) to mitigate their effects.

e. VBIED trends:

VBIEDs with suicide drivers are targeting coalition convoys. Initially these vehicles attempted to enter convoy formations on the move; however, this technique proved ineffective because of convoy speed and intervals. The emerging technique is to target stationary convoys or groups of Soldiers. Tactics, techniques, and procedures to mitigate the threat include the following:

- Hang signs written in Arabic stating, “Remain 100 meters from vehicle – Do Not Pass.” Signs should be visible at 50 meters.
- Use flares and non-lethal countermeasures as a warning device for vehicles which get too close.
- Employ any available electronic countermeasures.
- When convoy is halted, use cones and/or barriers with signs to keep vehicles 100 meters away.
- If a driver of a suspicious vehicle ignores these warnings and closes vehicle within 50 meters, shoot to kill the driver.

f. Characteristics of VBIEDs:

- Vehicles are usually sedans, some light trucks.
- Vehicle appears heavily-laden (rear axle weighted down).
- Usually single male drivers (normally in their mid-20s, but this is not always the case) dressed in normal Iraqi attire or dressed inappropriately for vehicle type. The male may be clean-shaven with a short haircut (part of the purifying ritual that many insurgents follow prior to a suicide attack).
- Aggressive or erratic driving style (this factor alone is insufficient to engage).
- Some vehicles are stationary on the side of the road and are detonated from a stand-off position.
- The enemy has been known to use broken-down vehicles, debris, or other obstacles to channel vehicles closer to the IED. This method ensures that the maximum damage is caused by the IED.



Figure 3-3: Damage resulting from VBIED attack

3. Communications:

a. **Voice and digital communications.** All convoys should have a frequency tracking chart within the vicinity of their radio systems. The chart should include all single channel and frequency hop channels programmed into their radios. Below is an example:

	CHANNEL		UNIT	FREQUENCY
S C	1	CIPHER TEXT	Primary Convoy Net	12.345
	2			
	3			
	4	PLAIN TEXT	Sheriff Net HANDCUFF	23.456
	5		Medical evacuation (MEDEVAC) in air	34.567
	6		MEDEVAC	45.678
F H	1 (CH 1)			
	2 (CH 1)			
	3 (CH 3)			
	4 (CH 3)			
	5 (CH 1)			
	6 (CH 1)			

Table 3-1

CENTER FOR ARMY LESSONS LEARNED

All convoys will depart with a primary and alternate means of communications. Cipher text (CT), frequency hop (FH) mode frequency modulation communications should normally be used as the primary means for voice communication. Digital equipment is secondary, followed by cellular phone or satellite phone. In the event of long periods without traffic (approximately 20 minutes), CC must conduct communications checks with each team leader.

The TC of vehicles with FBCB2 or BFT monitors the system for updated enemy situation and changes to road status.

Most units now have the Vehicle Intercommunication System (VIS) (AN/VIC-3[V]) designed for the TC to communication with the driver, gunner, and the rest of the platforms in the convoy. If a component goes down, this should be noted and fixed after mission is complete. Hand mikes should be available in case the VIS becomes inoperable.

Squad leaders should periodically conduct communications checks with any integrated communications (ICOM) radios. It is also common practice to give ICOM radios to civilians in the convoys. Communication checks must also be conducted with civilians. If escorting civilians who cannot speak English, the CC must make the effort to use pre-designated words with the non-English speaker. These pre-designated expressions help with command and control of the convoy. Make every effort to refrain from using personal handheld radios.

Ensure appropriate measures are taken so counter electronic devices do not negatively affect the communications of the convoy.

Place all antennas up.

b. Commonly used Iraqi words and phrases. It is important to have common Arabic words memorized for routine missions. This practice greatly enhances the squad's ability to control crowds or individual locals. Below are a few examples of common words or commands in English and how to say them in Arabic:

Weapons

hand gun	mussaddas
rifle	bunduqeea
machine gun	rashash
grenade	qumbula
mine	loghum

ammunition

thakheera

missile

sarookh

Commands

surrender

salem nafsak

come with me

taalu wyaya

calm down

ala kaifak

don't resist

la tgawem

form a line

awgafu bessaf

stay where you are

ibgu makankum

one at a time

wahed wahed

move

tharaku

hands up

irfauu idaikum

move slowly

itharaku ala kaifkum

come here

taal hnaheh

no talking

la tehchi (titkalam)

walk forward

itgadamu

stop

awgafu

don't move

la titaharraku

lower your hands

nazlu eidaikum

turn around

duru li wara

drop your weapons

thebu slahkum

Geographical Directions

north

shmal

south

janoob

east

shark

west

gharb

left

shmal

right

yameen

Can you show me?

rawnee?

Which direction did they go?

la wain rahao?

Friendly Polite Phrases

hello

marhaba

hello ("peace be with you")

essalaam alaikum

hello = response to above ("peace be with you too")

wa alaikum essalaam

goodbye

ma assalaama

please

bala zahmeh/min fahdlek

thank you

shukran

you're welcome

afwan

Helpful Words

good

zain

bad

mu zain

food

akel

water

my

help me

sa idnee

medicine

dawa

curfew

maamnoua itijawal

Helpful Phrases

Do you understand?	da tiftihim?
I don't understand	ani ma da aftihim
Where is the --?	wain el --?
Do you have --?	Endak --?
Can you help me find --?	Tigdar tsa ednee alga --?

4. Battle Drills

a. React to detonated IED:

- When traveling in a convoy and an IED detonates, all vehicles send an ammunition, casualty, equipment (ACE) report to the CC. All gunners will scan their sectors of fire for the enemy and attempt to positively identify the trigger man or cameraman. Once positive identification is confirmed, gunners will engage and destroy the enemy. The CC decides whether to stop or move the convoy to the nearest rally point in accordance with (IAW) the standing operating procedures (SOP). The CC's decision is influenced by the reports submitted from the TC; the CC prioritizes where medical assistance and/or vehicle recovery assets will be sent. The vehicle nearest any damaged vehicle drives to the scene and its occupants execute an immediate assessment of the situation and report all observations to the CC.
- Recovery decisions are based upon the feasibility to self-recover or if additional recovery assets are needed. If a unit can conduct self-recovery, it will recover its own vehicle(s) and move out of the kill zone to a location designated by the CC. When a vehicle is severely damaged and cannot be self-recovered, the convoy conducts fixed site security at the discretion of the CC and contacts the landowner for assistance.
- An air MEDEVAC request is based on the severity and number of friendly force casualties resulting from the attack. Another factor includes the distance between the attack site and the nearest forward operations base (FOB). Sometimes it is quicker to use ground MEDEVAC to a FOB if it is only a few miles away. Combat lifesavers and medics should also render buddy aid to increase the casualty's chances of survival. Continue the mission if neither personnel nor vehicles need recovery assistance.
- If the IED is detonated in the middle of the convoy, move both elements to a prescribed location out of the kill radius, and establish fixed site security on both sides to protect coalition forces and any pedestrians from the site. Team leaders must send an ACE report to the CC and await further guidance.

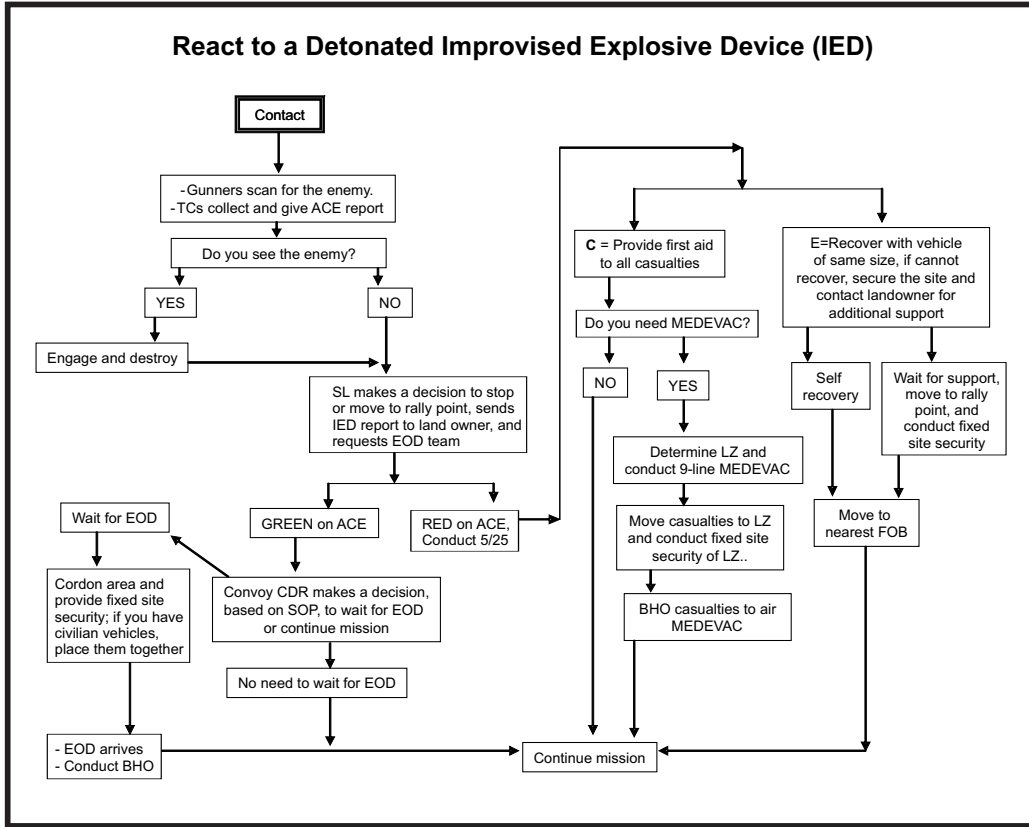

Figure 3-4

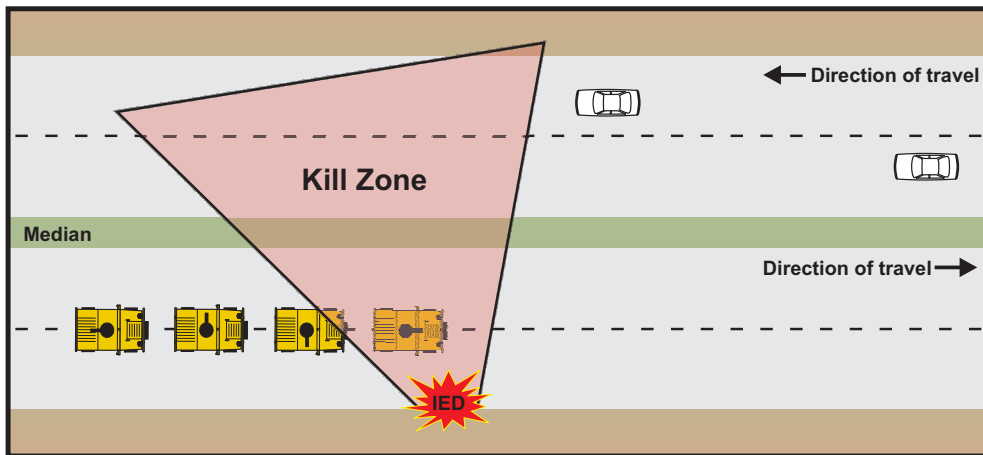

Figure 3-4a

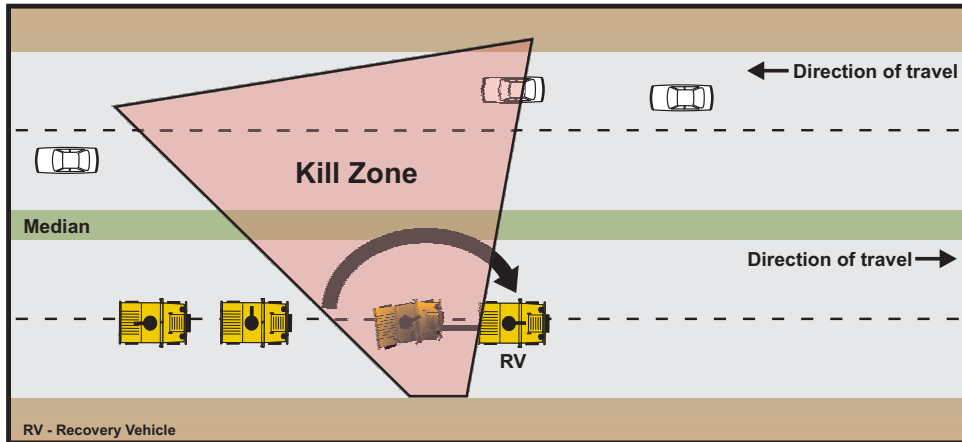

Figure 3-4b

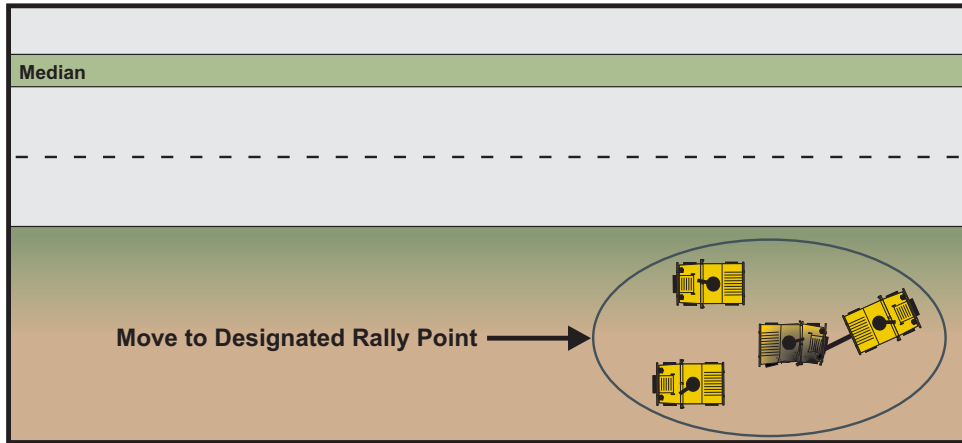

Figure 3-4c

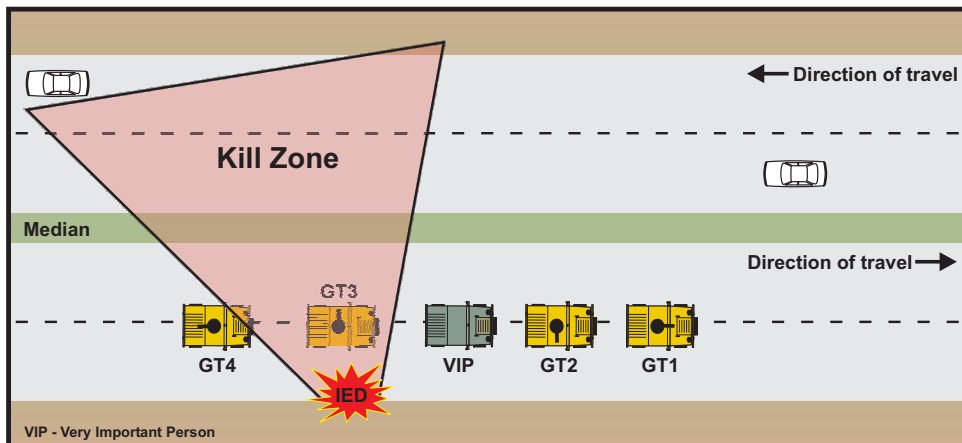

Figure 3-4d

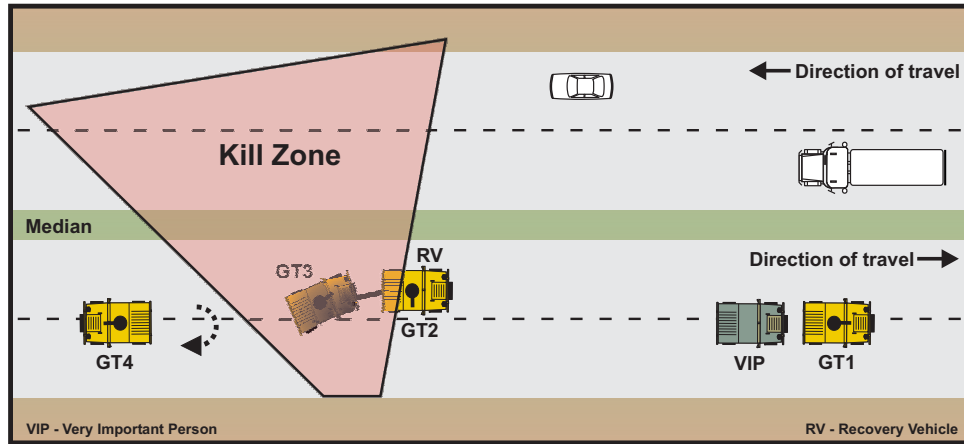

Figure 3-4e

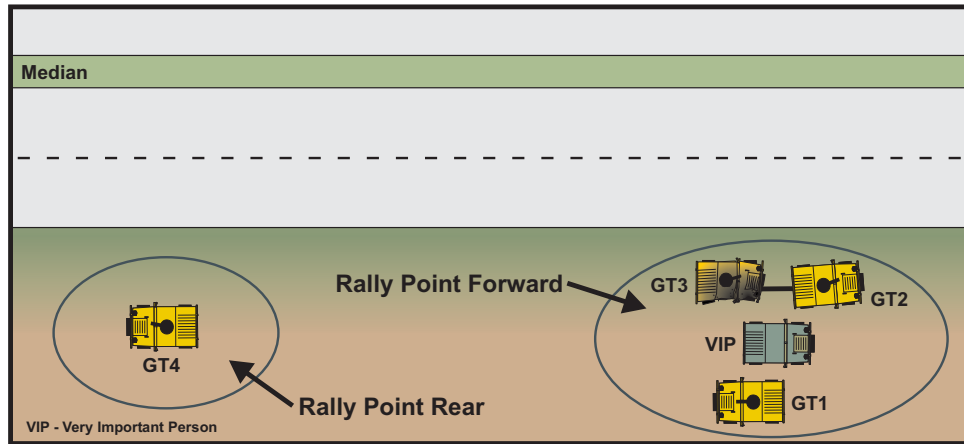

Figure 3-4f

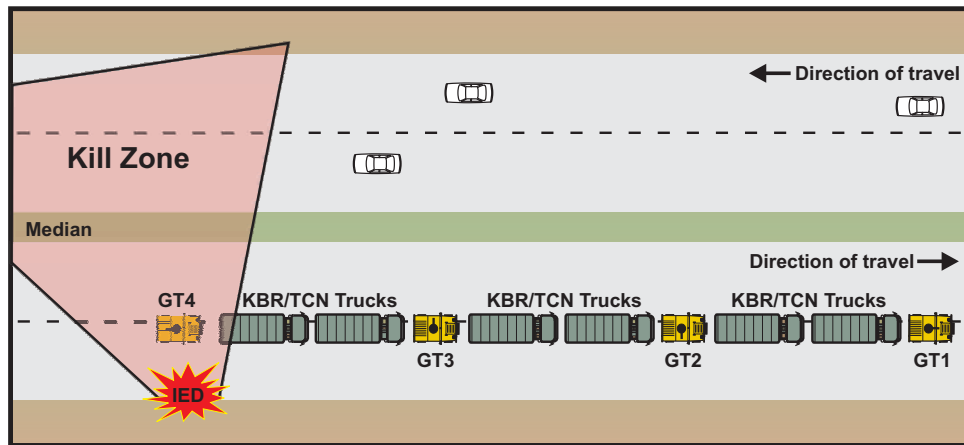

Figure 3-4g

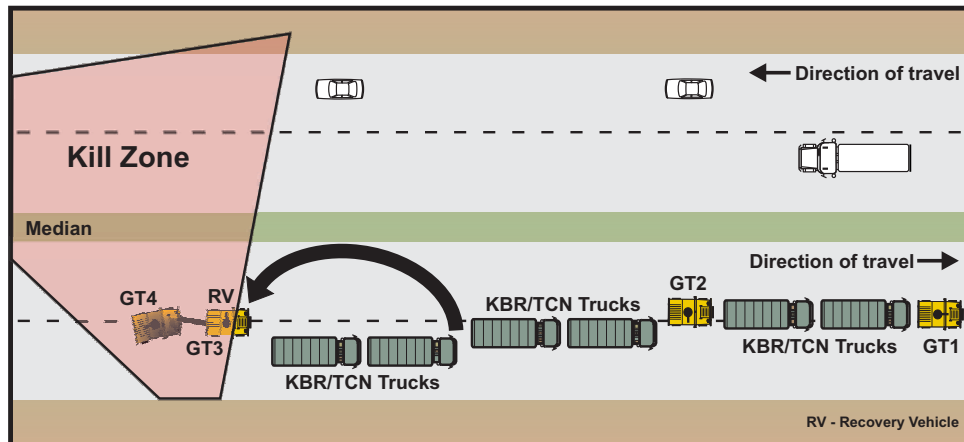

Figure 3-4h

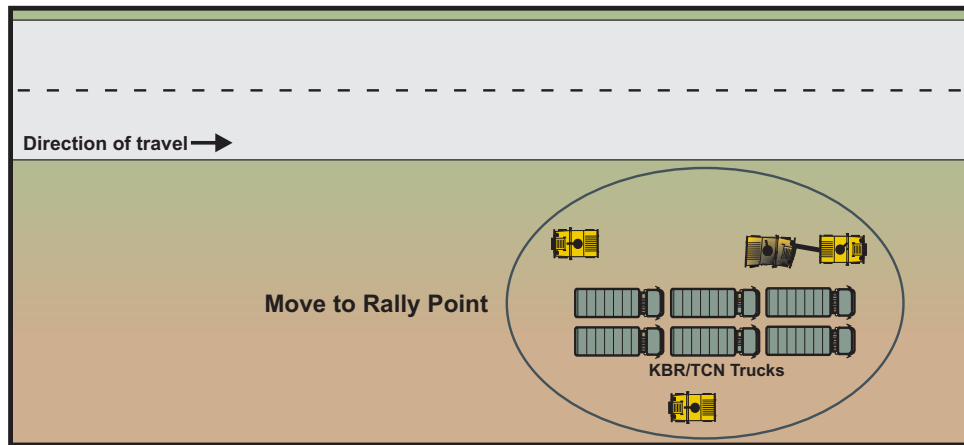

Figure 3-4i

b. React to a suspected or identified IED while on convoy:

- **PSD.** During convoy movements, occupants in lead vehicles have the highest odds of identifying possible IEDs. Whoever spots a suspected IED, that vehicle stops and its occupants announce the distance, direction, and description (3Ds) of the suspected device to the rest of the convoy via VIS. The TC directs gunner to scan for a possible ambush and widen their perimeter by conducting a “5 and 25” meter search for secondary IEDs, a triggerman, a cameraman, and other potential hazards.
- The convoy must then confirm and check the suspected IED. If it is not an IED, continue the mission. If it is an IED or an undeterminable device, move vehicles away from the kill zone to a safe distance while continuing to secure the VIP. The security team clears, cordons, and controls the site from any traffic or pedestrians, while also conducting fixed site security of the affected area. The SL sends up an IED/UXO 9-line to the landowner, requesting explosive ordnance disposal (EOD) support. Upon

arrival of the quick reaction force (QRF) and EOD, the PSD will conduct a battle handover (BHO) and continue the mission.

- **Additional considerations for large convoys containing civilian vehicles.** When escorting logistical convoys such as Kellogg, Brown, and Root, which include numerous large vehicles, the greatest concern is the flexibility of movement. A closer ratio of gun truck to logistical trucks increases the survivability of convoy elements. One major consideration is the ability of truck drivers to speak English and how unit personnel will communicate with drivers who do not know English. One method used in theater is to give the local truck drivers a communication device linking them to an interpreter for any instructions the unit leadership transmits. If the civilian drivers do not have communications systems, it is advisable for the convoy leadership to supply such devices.
- If a suspected IED is cleared, continue the mission. If the device is undeterminable or a confirmed IED, the CC chooses a location to muster the civilian vehicles and then clears, cordons, and controls the site while conducting fixed site security.

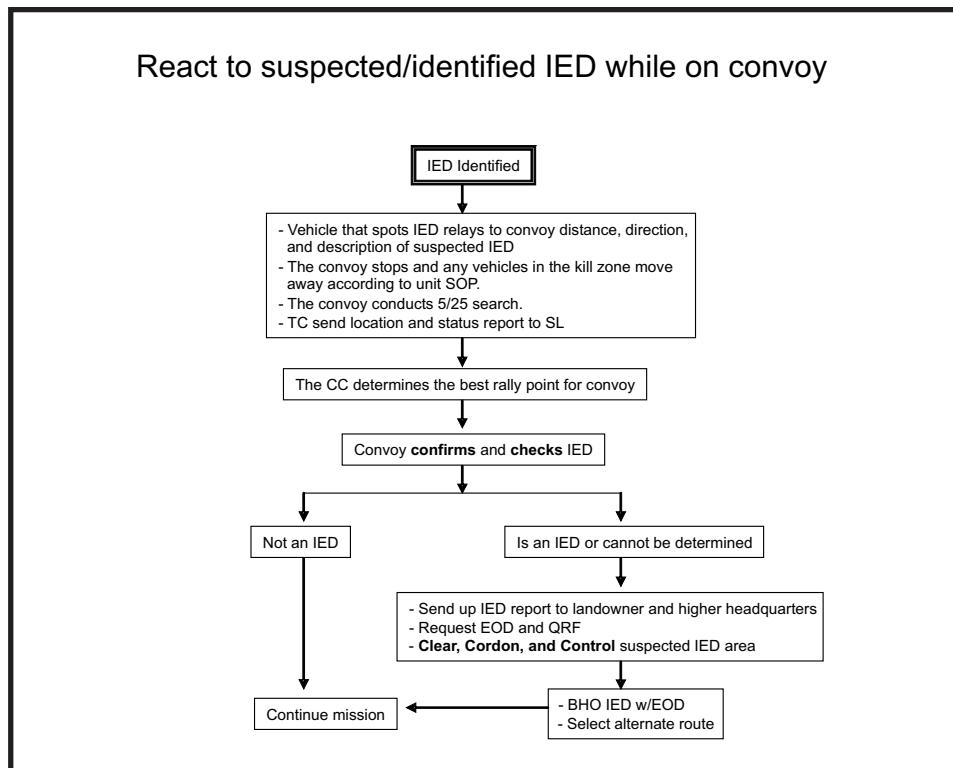

Figure 3-5

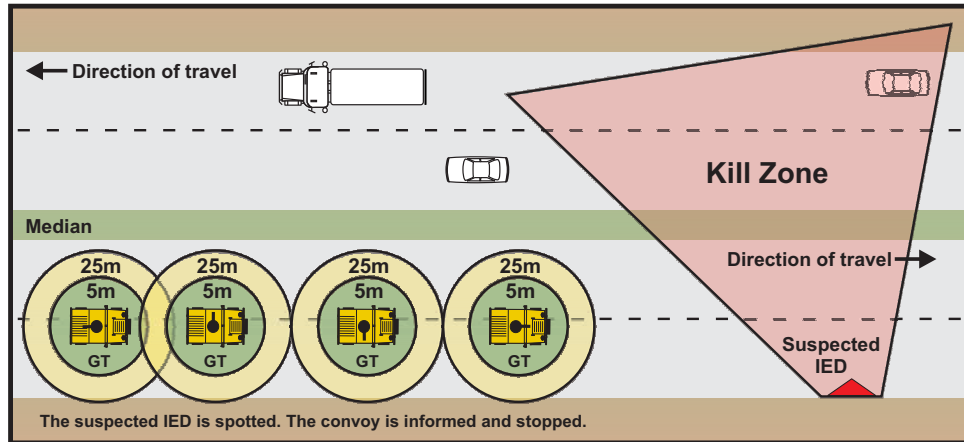

Figure 3-5a

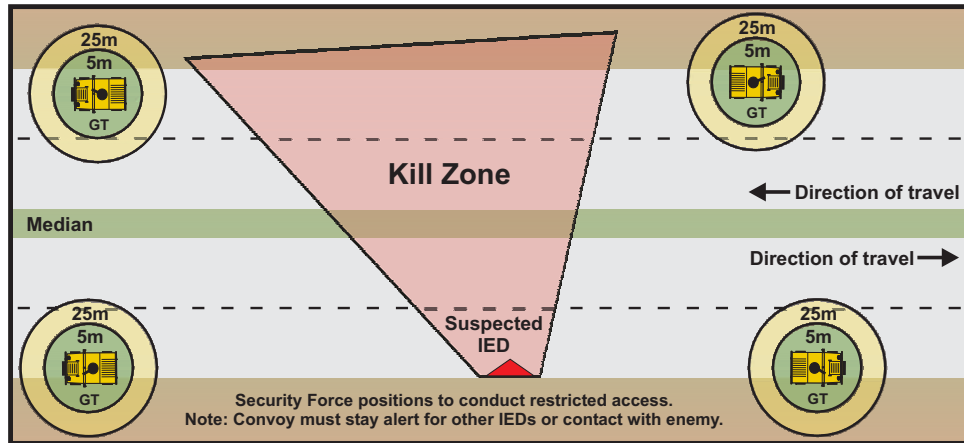

Figure 3-5b

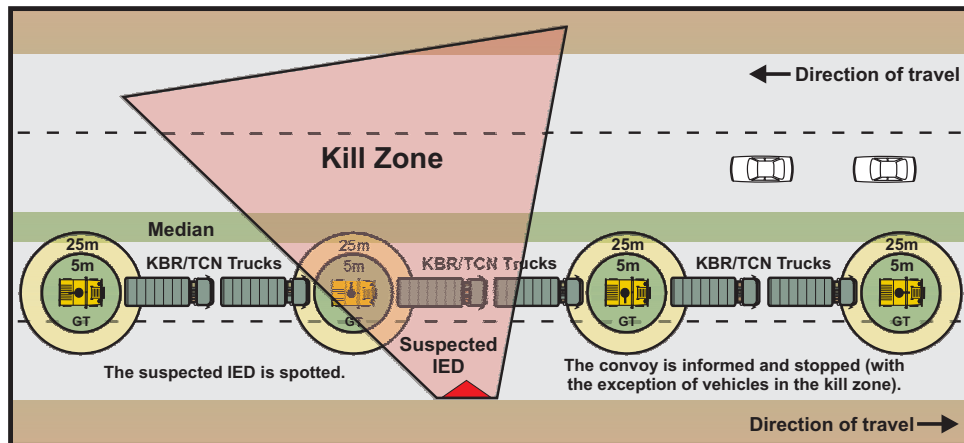

Figure 3-5c

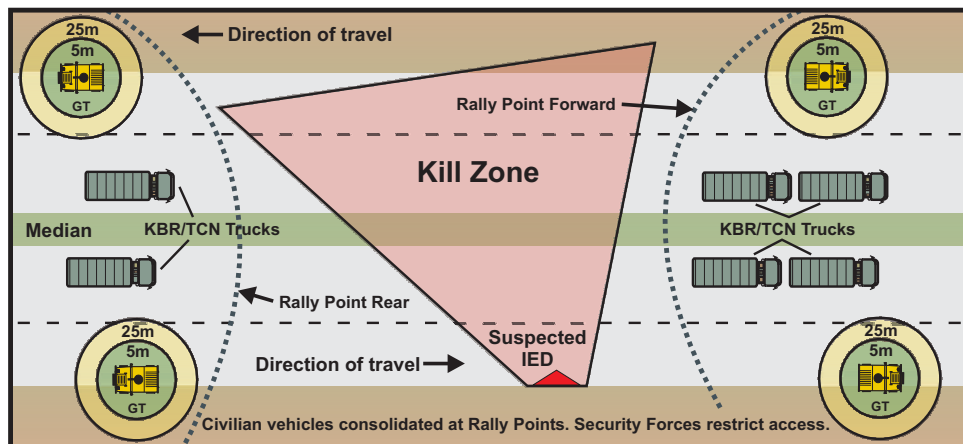

Figure 3-5d

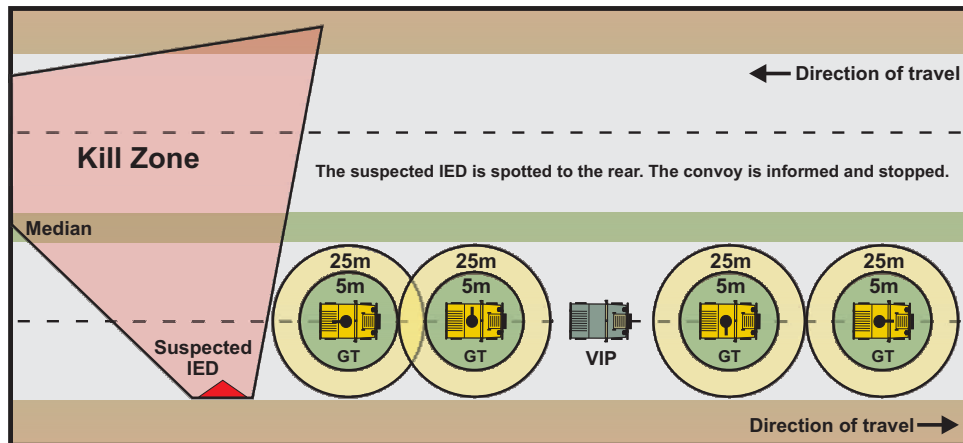

Figure 3-5e

c. React to mobile VBIED while on convoy:

- PSD.** Once a gunner identifies a suspected VBIED, the gunner informs Soldiers on the convoy net of the impending danger. The closest gunner begins executing the EOF measures to eliminate the threat. If the EOF succeeds with non-lethal effects, then the convoy continues its mission. If the non-lethal EOF fails, but lethal effects reduce the threat, move the convoy to a safe area, secure the site, and send the landowner a report. CCs must be prepared to build storyboards after every serious incident. Upon arrival of landowner forces, conduct a BHO and continue the mission. If the lethal EOF fails, the gunner immediately drops inside the vehicle, seeks cover, and informs the rest of the team members to prepare for the impending blast. Once the blast occurs, send a situation report to the landowner and higher headquarters (HQ) (refer to the detonated IED battle drill).

- Additional considerations for large convoys with civilian vehicles.**
 The CC informs civilian personnel of the situation so they can stop and also seek cover from a possible blast using communication devices such as ICOMs (handheld radios) or cellular phones. If no communication devices are available, use a prescribed signal to transmit information. After the blast, civilian personnel should give a personnel status to the CC in the event personnel may need medical attention or recovery assets.

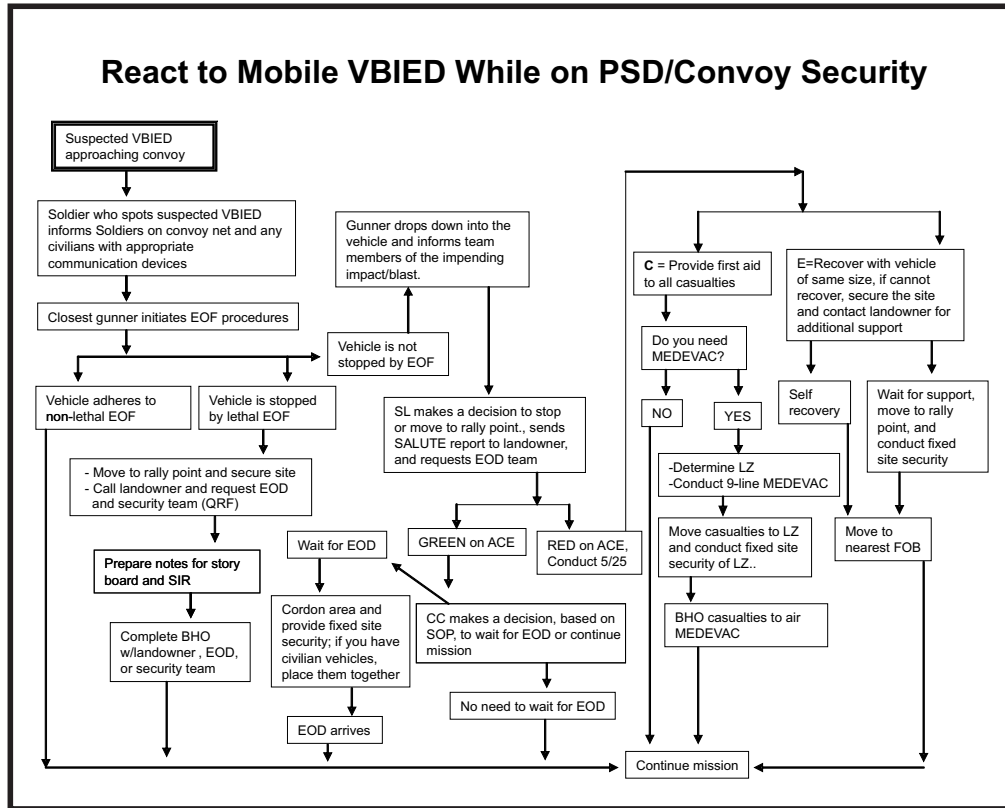

Figure 3-6

The VIP level and the VIP's mission must be considered in this type of situation. The ultimate decision as to the best option for IED security is left to the convoy commander and the land owner. They will have to balance VIP safety with the safety of other passing convoys.

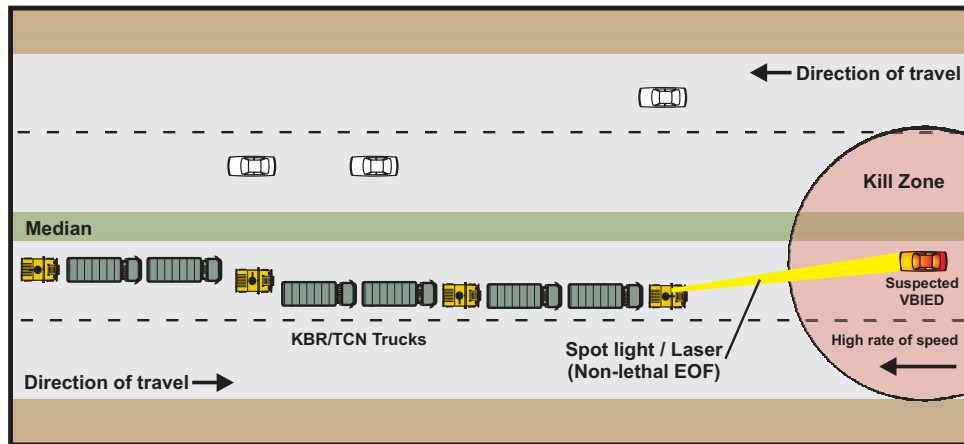

Figure 3-6a

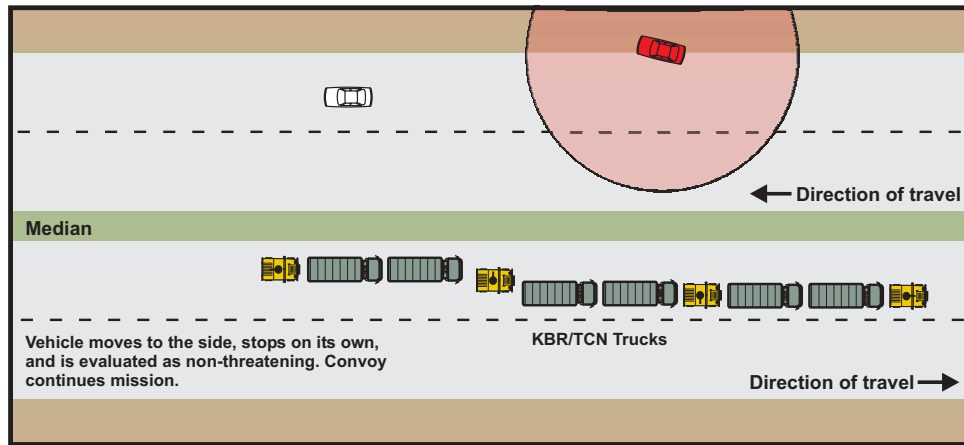

Figure 3-6b

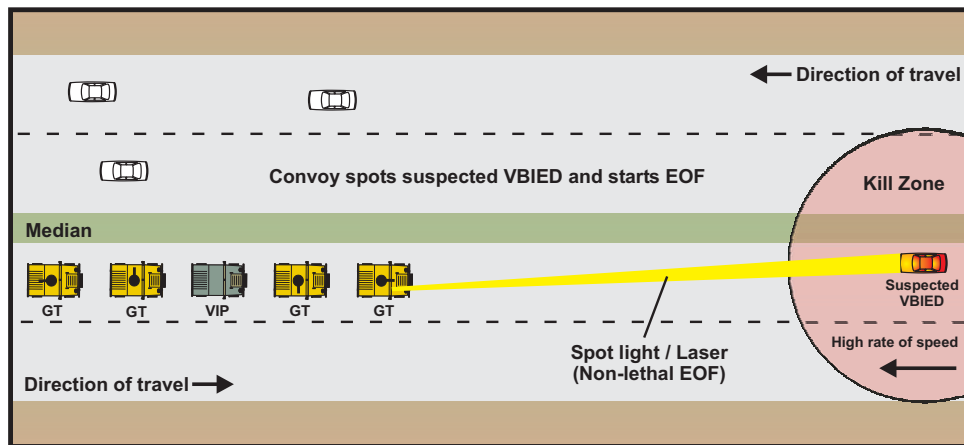

Figure 3-6c

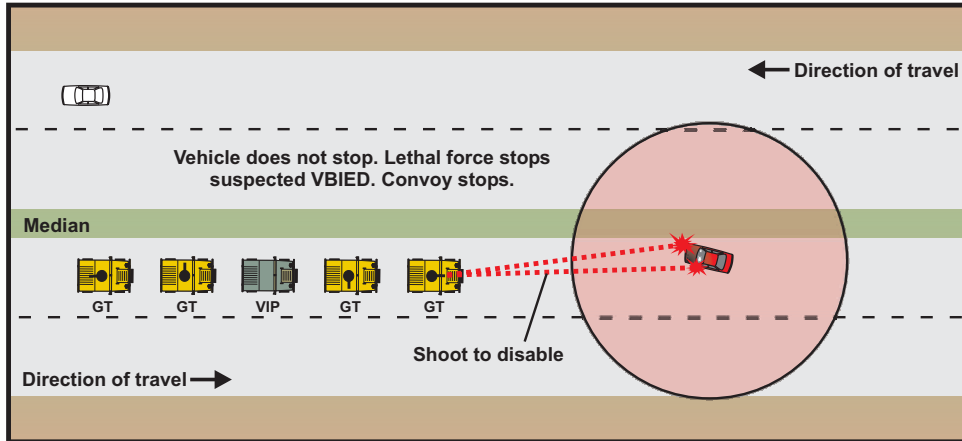

Figure 3-6d

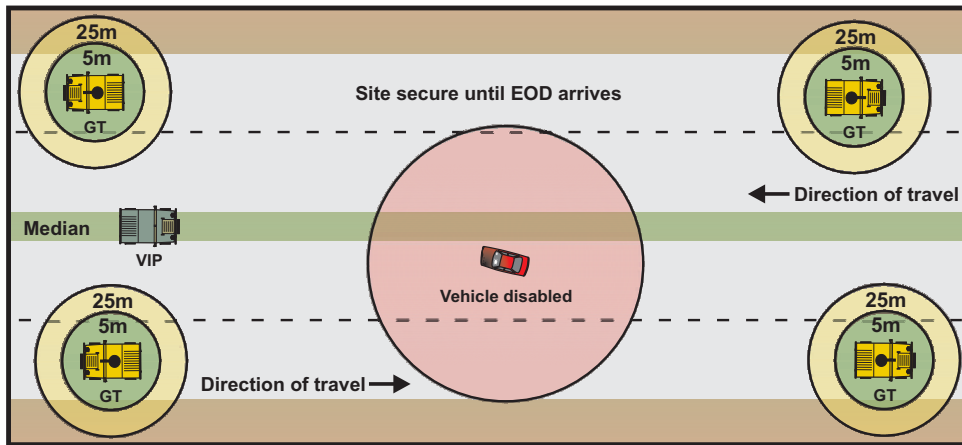

Figure 3-6e

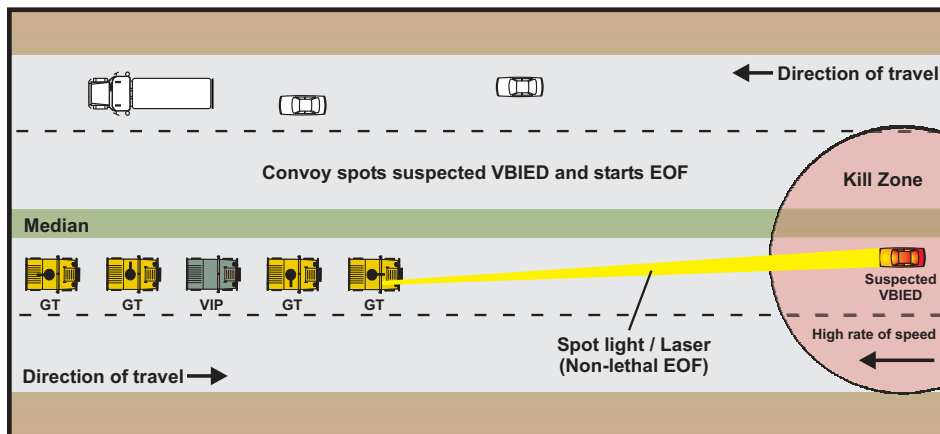

Figure 3-6f

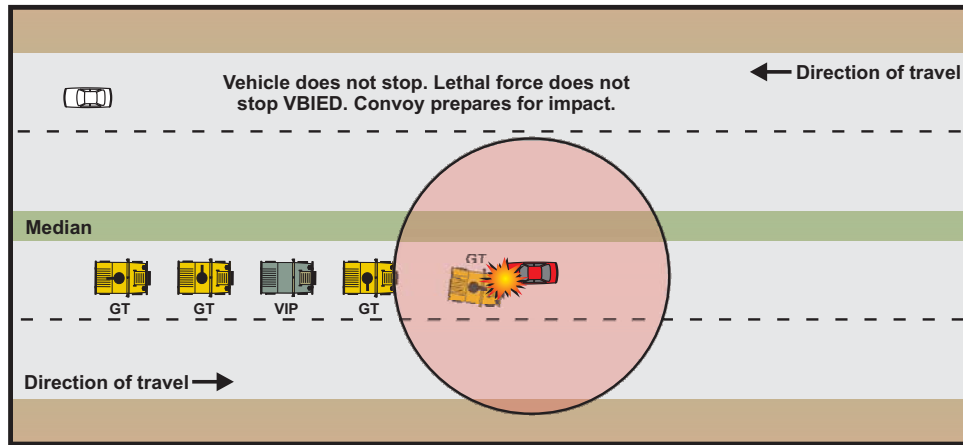

Figure 3-6g

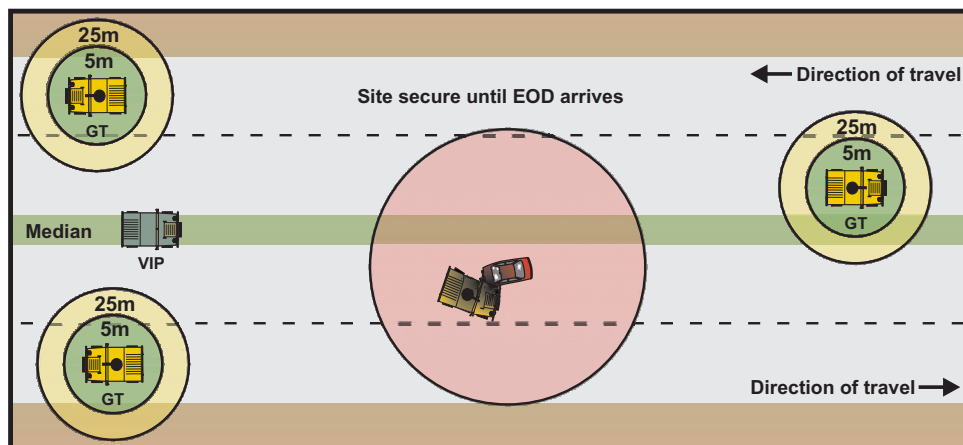

Figure 3-6h

d. React to blocked/unblocked ambush: Small arms fire (SAF), rocket propelled grenade, grenade:

- Blocked ambush.** Security force units escorting large logistical convoys in theater might encounter blocked ambushes. Upon contact, the gunners must achieve fire superiority and positively identify the enemy's location. The TC simultaneously sends up the SALUTE report to the CC. The CC sends up a SALUTE report via the sheriff's network to the landowner and determines if a QRF is needed. The CC may decide to maneuver and destroy the enemy, or move the convoy to a rally point because of the lack of friendly forces or firepower. If the convoy moves to a rally point, all TCs will send an ACE report to the CC, and in turn the CC sends the information to higher HQ for further guidance. If the CC decides to maneuver and engage the enemy, he does so until the enemy is either

captured or destroyed. Following the action against the enemy, the convoy moves to a rally point, ACE reports are submitted to the CC, and TCs wait for further guidance. A security posture used during VIP escort is to box the VIP vehicle in the middle while providing fixed site security. During large logistical convoys, the vehicles are placed in the center while the gun trucks provide security.

- Consideration during an unblocked ambush.** Security force units escorting logistical convoys in theater encounter unblocked ambushes more frequently than blocked ambushes. Upon contact, gunner announces 3Ds of the enemy attack, returns fire, scans for trigger men and/or cameramen, and tries to eliminate the threat through mass in firepower. The team leaders send their ACE reports to the CC who contacts the landowner and HQs by sending a SALUTE report. If there are casualties, they will be assessed for the need of either air or ground MEDEVAC. If there are no casualties or no severe damage to vehicles prohibiting travel, continue mission.
- Considerations during sniper fire.** In the case of sniper fire, the gunner drops below the height of his protective armor and receives updated enemy location from the TC and driver. Once the sniper has been identified, the gunner re-mans the weapon system and engages in the direction of the sniper and continues to engage until the threat is eliminated or the convoy moves out of kill zone. If casualties are involved, treat IAW SOP. If the vehicle is damaged, conduct the appropriate vehicle recovery drill.

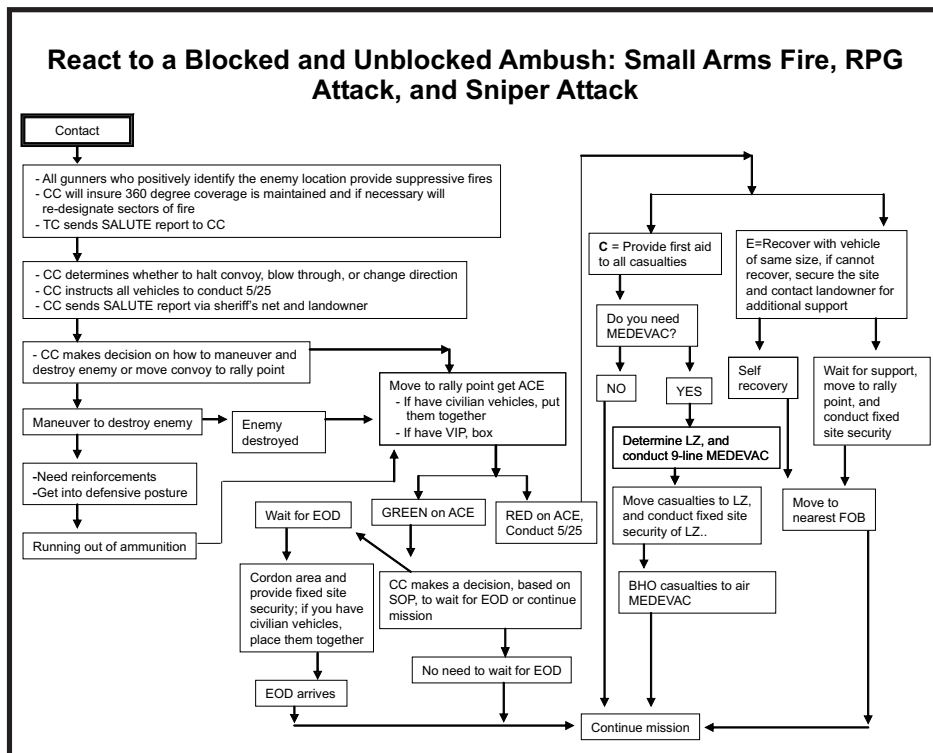

Figure 3-7

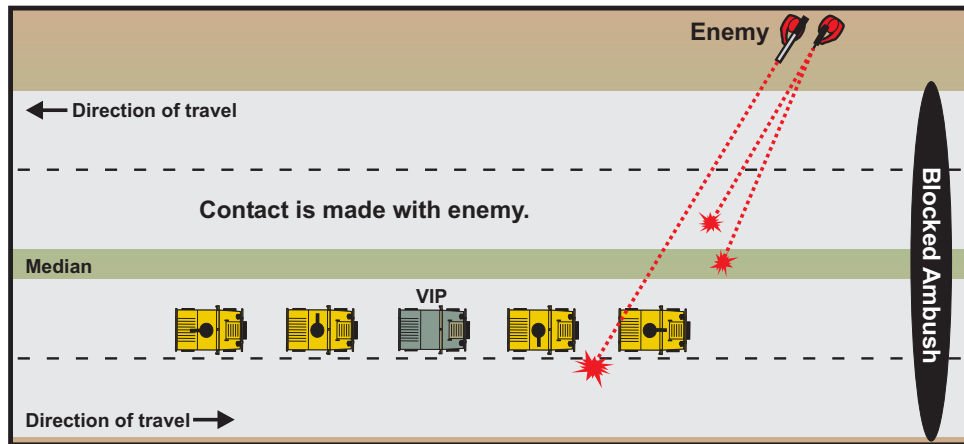

Figure 3-7a

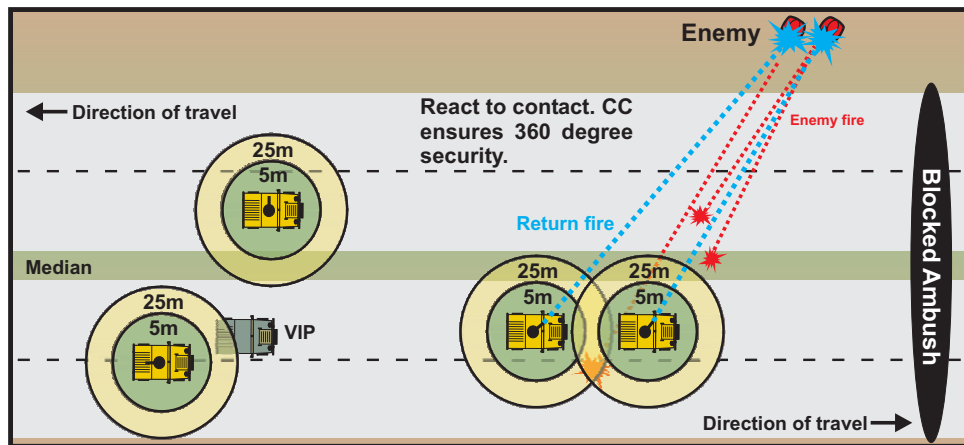

Figure 3-7b

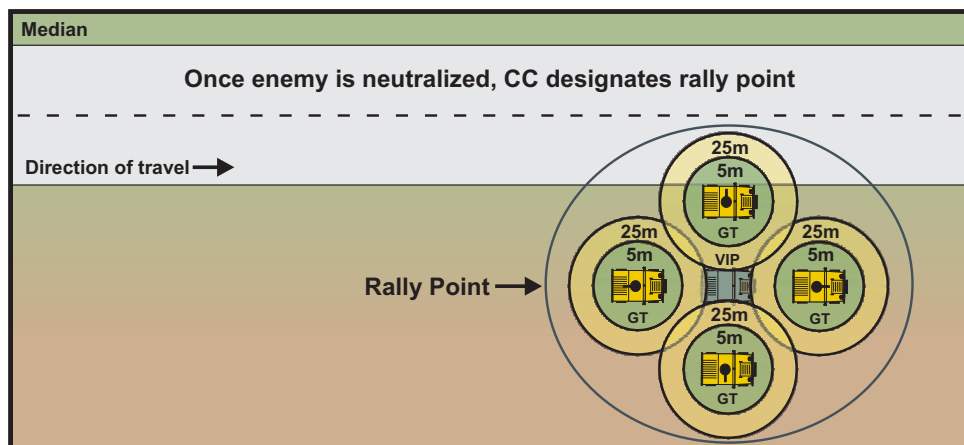

Figure 3-7c

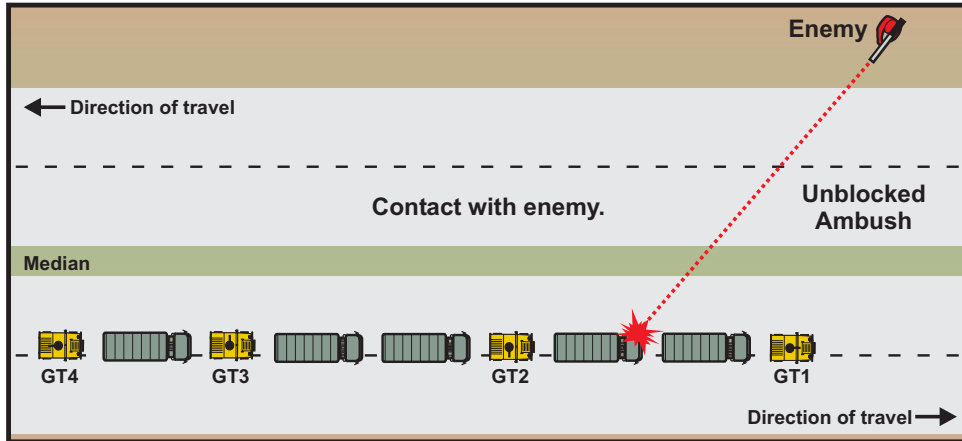

Figure 3-7d

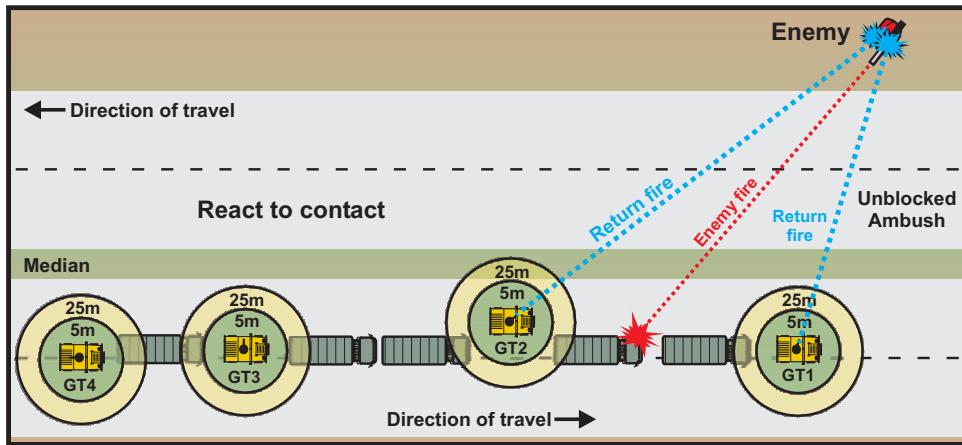

Figure 3-7e

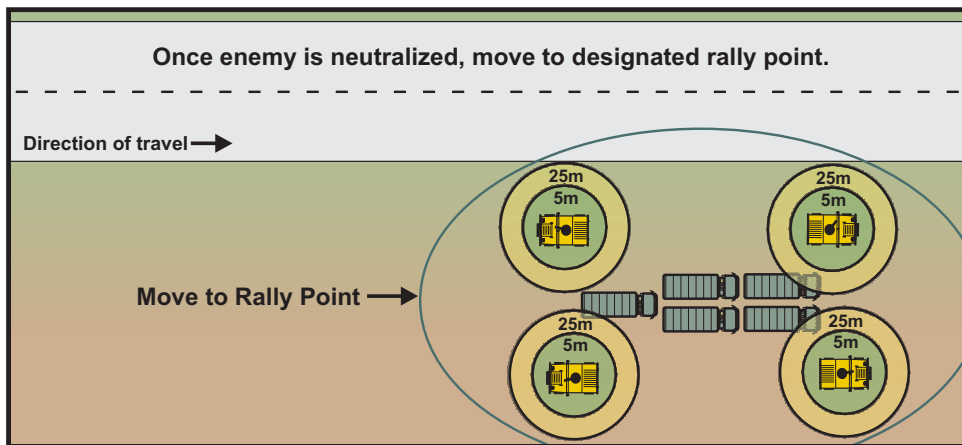
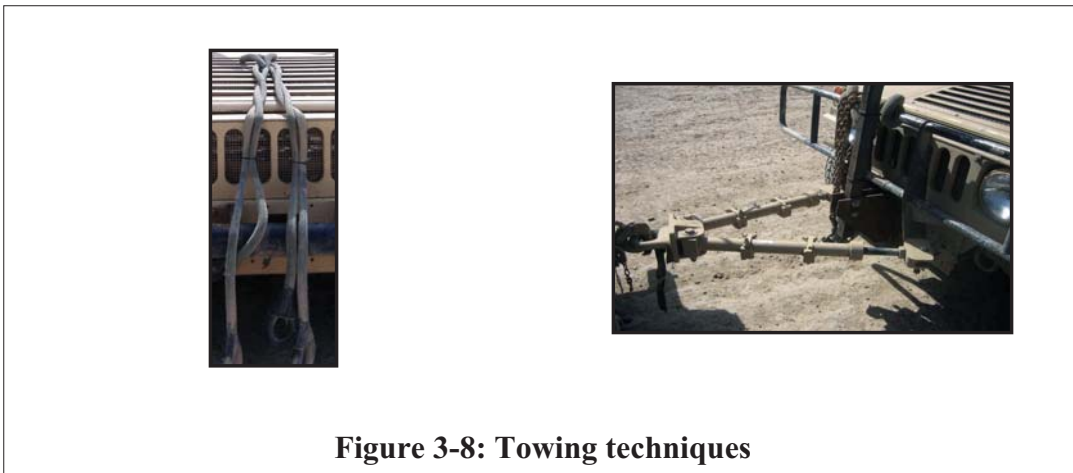

Figure 3-7f

e. **Hasty/deliberate recovery on downed vehicle.** All convoys must have a plan for self-recovery from breakdowns in addition to a primary and alternate recovery team. CCs must always keep in mind vehicles might have to be pulled, pushed, or dragged by compatible vehicles in order to be extracted from the site.

- **Hasty recovery.** The recovery team quickly positions itself on the safest side of the disabled vehicle and makes an assessment of the damaged vehicle. The TC dismounts and assesses the disabled vehicle's hook up point to determine if it is still feasible to conduct the hook up considering the damage and the terrain. The TC also looks for any obstruction preventing a hasty recovery. Some tools used for a hasty recovery include chains, tow-straps, and cables. If the damaged vehicle can be safely recovered, the TC guides the recovery vehicle into a position that allows a regular hook up. If uninjured, the driver of the disabled vehicle assists in the recovery operation. If the driver of the damaged vehicle is a casualty, the TC of the damaged vehicle operates the vehicle. Once the hasty hook up is complete, the vehicle towed is taken to a rally point or nearest military site where it can be repaired or where more appropriate (heavier) towing devices may be used for a longer haul. Civilian vehicles can be towed by compatible vehicles or remain secured on site until proper recovery assets arrive. A technique used for civilian trucks is to take an additional semi-truck without a trailer and replace it with the damaged semi-truck's trailer and leave the damaged head for recovery operations.



- **Deliberate recovery.** During deliberate recovery operations, similar actions apply with the exception of the time available, tools, and vehicle. After determining that the vehicle is not able to move under hasty recovery operations, the TC informs the CC about the damaged vehicle. If a tow-bar needs to be applied, the CC establishes a fixed site security and sends a situation report to the landowner with the following: number of vehicles to be recovered, types of vehicles, vicinity grid location, brief description of breakdown, movement tracking system (civilian trucks), his call sign, and a detailed description of the problem (rollover, etc.). Once the landowner's assets arrive and recovery is complete, seek further guidance from higher HQ.

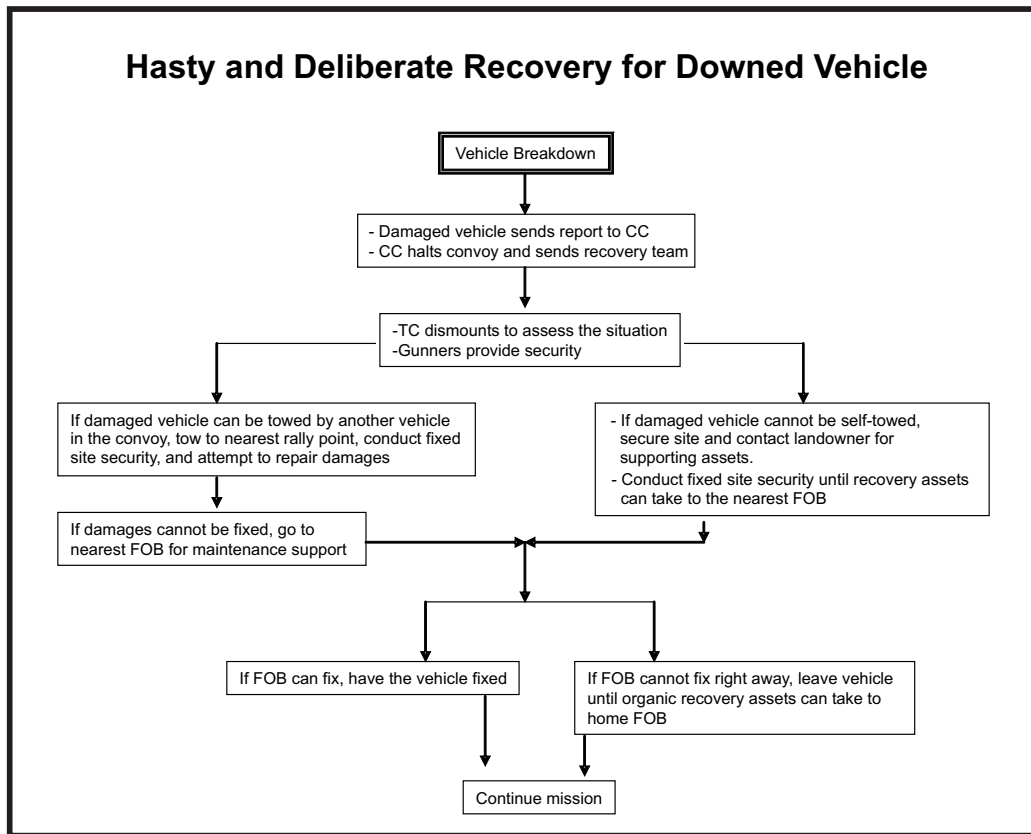

Figure 3-9

f. **React to a congested area.** This drill establishes procedures for actions taken by a convoy when forced to stop because of a congested area. The intent of the drill is for the lead vehicle and the CC to assess the situation, to find an alternate route by safely bypassing the congested area, and/or to use non-lethal means to disperse the crowd. This drill provides basic considerations.

- Road is blocked by a crowd.
 - CC dictates a prescribed distance away from the crowd in order to provide security to all convoy assets.
 - The driver of the lead truck notifies the CC to give a location and an assessment of the situation. If the convoy can circumvent the crowd, then an alternate route will be used after attaining permission from the landowner.
 - If the convoy cannot use an alternate route, the CC designates a team of gun trucks to prevent the crowd from reaching the security force. The gun trucks execute a blocking formation in the direction of the crowd.
 - The lead gun truck initially uses non-lethal devices such as hand/arm signals, spotlights, air horn, and/or lasers in order to

disperse the crowd. Additional gun trucks may be required to assist with blocking or crowd dispersing, depending on level of congestion and hostility of the crowd.

- If equipped with the medium range acoustic device (MRAD), the MRAD gun truck drives within a close range of the crowd and sounds the siren in three bursts. If that does not work, the CC uses an interpreter to transmit his message for the crowd to disperse.
- When the lead element determines the crowd is passable, the CC receives notification to move the convoy forward. If crowd is still persistent and does not allow passage, contact the landowner and request supporting assets to reduce the possible threat.
- Continue mission once cleared from the crowd.

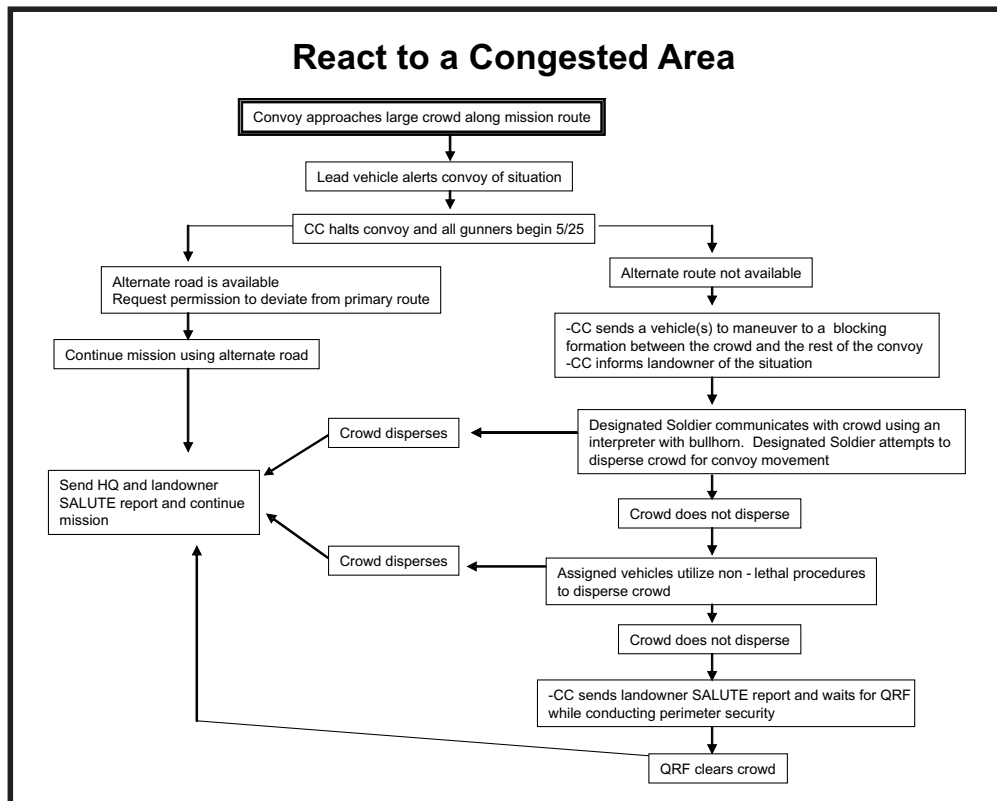

Figure 3-10

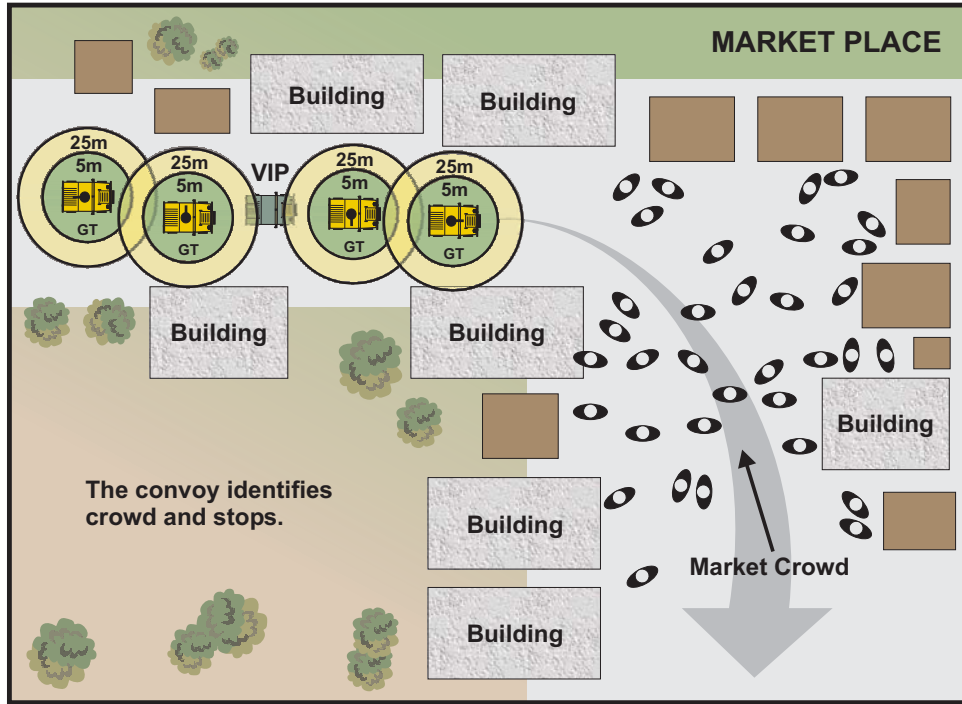

Figure 3-10a

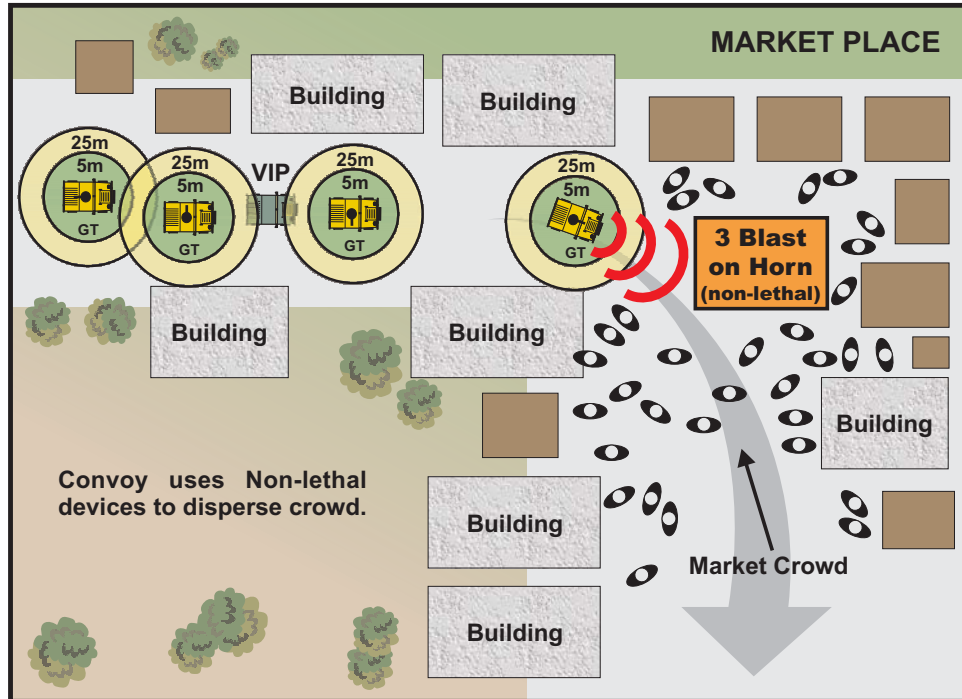

Figure 3-10b

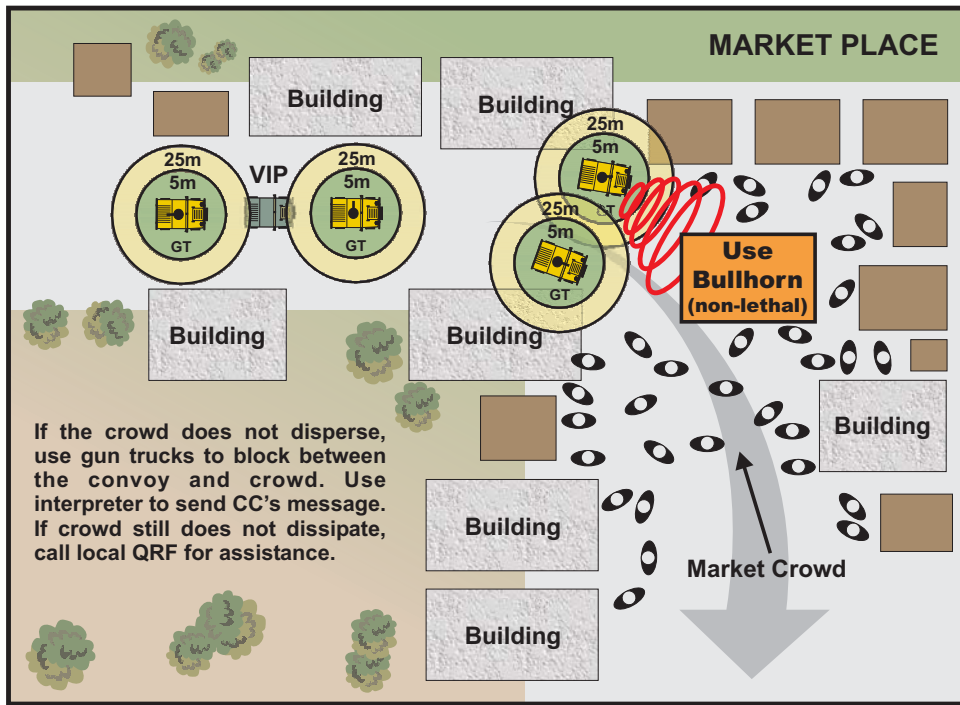

Figure 3-10c

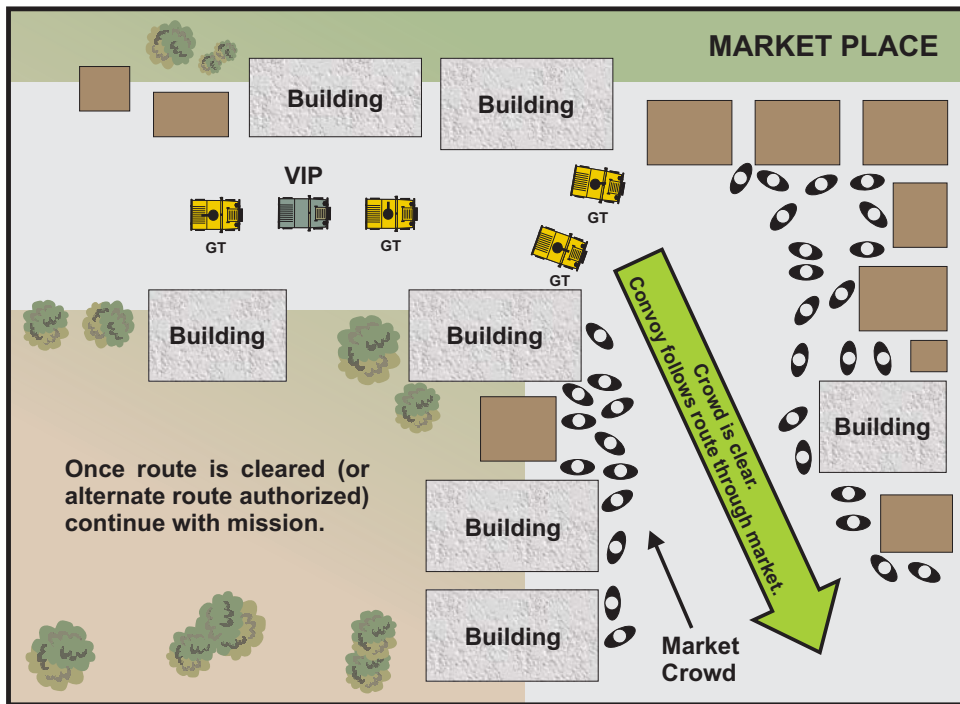

Figure 3-10d

g. **Overpass battle drill.** Overpasses continue to be structures where the enemy stages its attacks on coalition convoys. Attacks range from SAF to explosive devices dropped into a passing vehicle. The overpass serves as an effective place to employ elevated IEDs targeting gunners. Soldiers need to approach overpasses with a heightened sense of vigilance at all times. Hazards that gunners might encounter include wire placed across the path of the gunner's neckline and rocks dropped from the overpass. Gunner must be at the lowest profile in order to avoid such dangers.

- Once the gun truck approaches an overpass, the driver and TC alert the gunner by saying, "Overpass!" When the driver is at a predetermined distance from the overpass, the gunner scans the near side of the overpass using a spotlight or a high-powered beam (during night operations). If the gunner identifies or receives fire from the enemy, engage and destroy the target. When the truck is at a predetermined distance from the bridge, the gunner drops into his hatch, with an individual weapon in one hand and a spotlight (during night operations) in the other. The gunner then scans underneath the pass for any suspicious devices. The driver accelerates and continues vehicle on its path until it successfully negotiates through the overpass. The gun truck's headlights should remain on so the crew can scan under the bridge for road spikes, wire, and IEDs.
- Once the truck passes the bridge, the gunner announces "clear" and stands back up. He should quickly scan the opposite side of the overpass using a spotlight (during night operations) to detect any enemy activity.

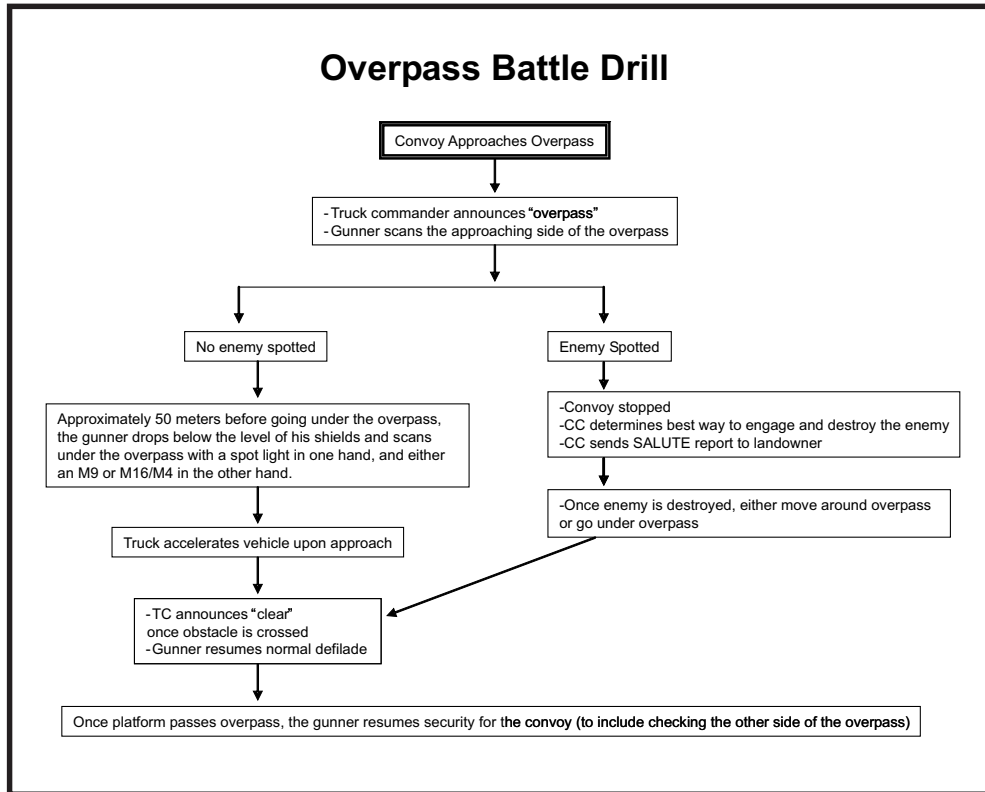

Figure 3-11

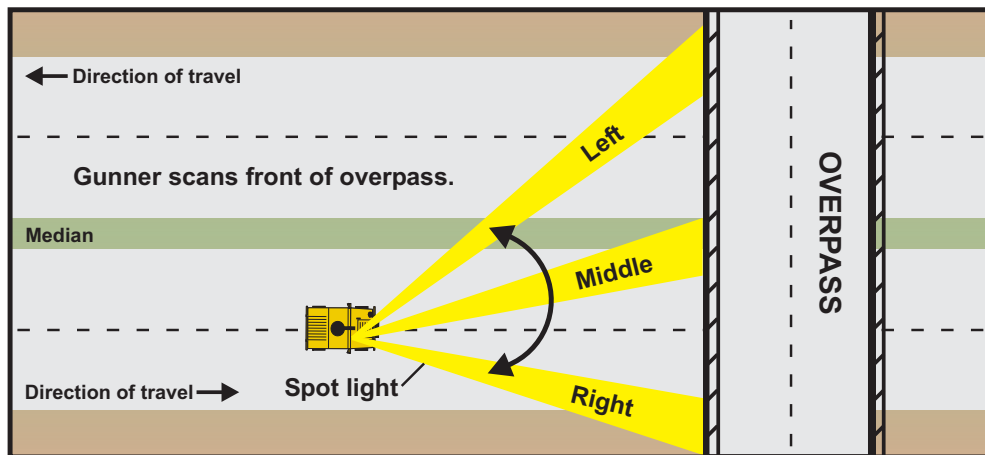

Figure 3-11a

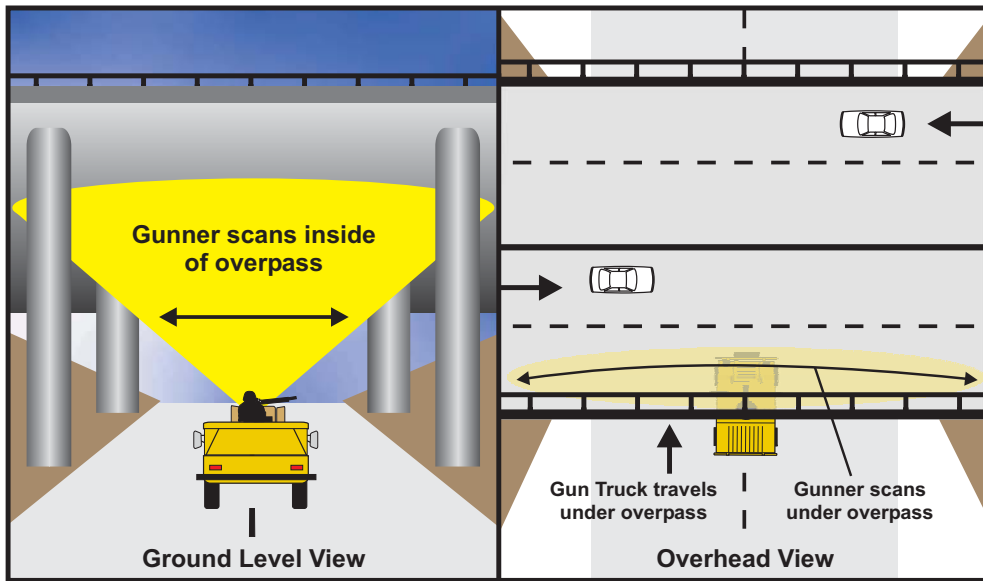

Figure 3-11b

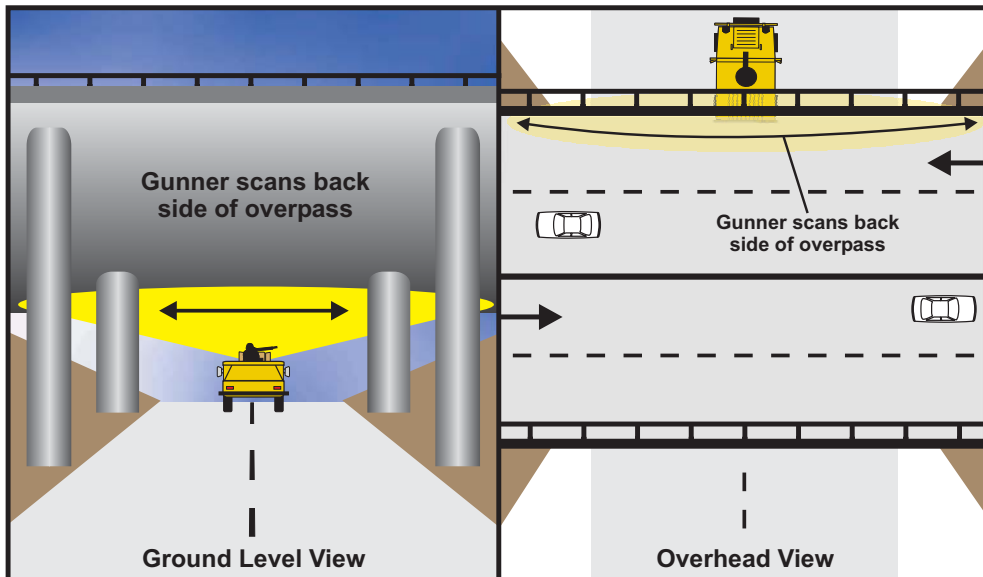

Figure 3-11c

h. **Gunner down drill.** It is important for the crew of a gun truck to know and rehearse the battle drill for replacing an injured gunner. The cab of the M114, equipped with the BFT/MTS and Single-Channel Ground and Airborne Radio System (SINCGARS), is very tight, and movement in the cupola is restricted especially when the gunner is wearing the Cupola Protective Ensemble (CPE).

This drill begins when the gunner of the vehicle sustains an injury or is killed during contact with the enemy. The steps of this drill vary depending on how many personnel there are in the gun truck. If possible, the gunner states, “(Name of TC), I am wounded, man my weapon!” If the TC has an ICOM he hands it to the driver and assists the gunner out of the turret by releasing the gunner’s safety restraint system. Once he releases the gunner, the TC should render buddy aid and make a quick assessment on the severity of the injury the gunner has sustained. If an immediate assessment cannot be made, removal of the CPE is necessary for further investigation. When the gunner is stable, the TC enters the turret and mans the weapons system. The driver simultaneously notifies the CC that the gunner is injured. The convoy moves out of the kill zone and the occupants continue to look for the cause of the injury (enemy or device) until the convoy is able to stop at a secured rally point. While performing first-aid or casualty evacuation (CASEVAC) operations, conduct fixed site security for the convoy. If another gunner is available, replace the downed gunner and redesignate sectors of fire.

i. **Driver down drill.** If the driver is down due to contact with the enemy or other causes, the following steps should be taken:

- Gunner drops down, controls steering wheel, applies brakes to bring the vehicle to a full stop, and takes control of the vehicle.
- TC climbs over driver’s side, pulls driver over the middle of the vehicle.
- TC informs CC immediately of situation.
- Gunner takes over driving until out of kill zone.
- TC evaluates and applies first aid to driver.

j. **Vehicle rollover drill.** Due to additional protective enhancements to the M1114, such as additional armor, gunner cupolas, and reinforced protective devices, the high center of gravity on the M1114 has created a rollover safety concern.

Before rollover:

The driver:

- Releases the accelerator.
- Shouts, “Rollover, Rollover, Rollover!”
- Leans to the right, keeps one hand on the wheel, and braces for an impact.
- Using alternate hand, driver assists TC in pulling gunner into the vehicle.
- Shuts down the engine.

TC:

- Leans to left and holds onto the radio mount.
- Shouts, “Rollover, Rollover, Rollover!”
- Using alternate hand, assists driver in pulling gunner into the vehicle.
- Releases gunner seat.

The gunner:

- Drops down from the hatch into the vehicle.
- Holds onto a stationary object.
- The driver and TC each grab the gunner’s legs to assist him into the vehicle.

After the rollover:

The driver:

- Activates the fixed fire extinguisher, if available.
- Disconnects the microphone plug, if applicable.
- Checks for injuries and seeks medical attention as needed.
- Exits the vehicle (uses the rescue wrench mounted inside the vehicle, if necessary).
- Checks for fuel spills and attempts to contain them, if possible.

The vehicle commander:

- Checks the crew for injuries and seeks medical attention as needed.
- Disconnects the microphone plug, if available.
- Exits the vehicle with the crew (uses the rescue wrench mounted inside the vehicle, if necessary).
- Accounts for personnel and sensitive items.
- Checks for fuel spills and attempts to contain them if possible.
- Reports to higher HQ.
- Seeks recovery of assets.

The gunner:

- Clears the weapons.
- Checks the weapons' serviceability.
- Disconnects the microphone plug, if available.
- Removes CPE helmet and air hose, if available.
- Exits vehicle, assists the driver, secures site, and waits for QRF.

Note: Special considerations for non-swimmers should be taken into account for rollovers into water. Time spent getting out of the turned-over vehicle is more critical when the vehicle is submerged in water.

k. Crew-served weapon down during enemy contact drill. When the gunner's primary weapon goes down, the gunner announces "Weapon Down!" and immediately secures his alternate weapon system. The TC immediately informs the CC of the downed weapon system. The CC reassigns sectors of fire to cover the sector of the temporary disabled weapon. The gunner immediately shifts to the alternate weapon system. Once the enemy is neutralized and the gunner is out of danger, the gunner performs immediate action on the primary weapon system.

l. Fixed site security in open area. On occasion, convoys may have to stop along their route. Possible reasons include vehicle breakdowns, securing a suspected IED, or waiting for a link up. The gunners must be vigilant and report any suspicious activities to the CC and be ready to take action if needed. The driver and TC should also scan the area until recovery assets or relief arrives. Concertina wire can be put out to keep children and locals away from the immediate area if the convoy will be on site for an extended period of time. The threat level of the area must be considered prior to emplacing an outer perimeter, as it may hinder an expedient exit from the location.

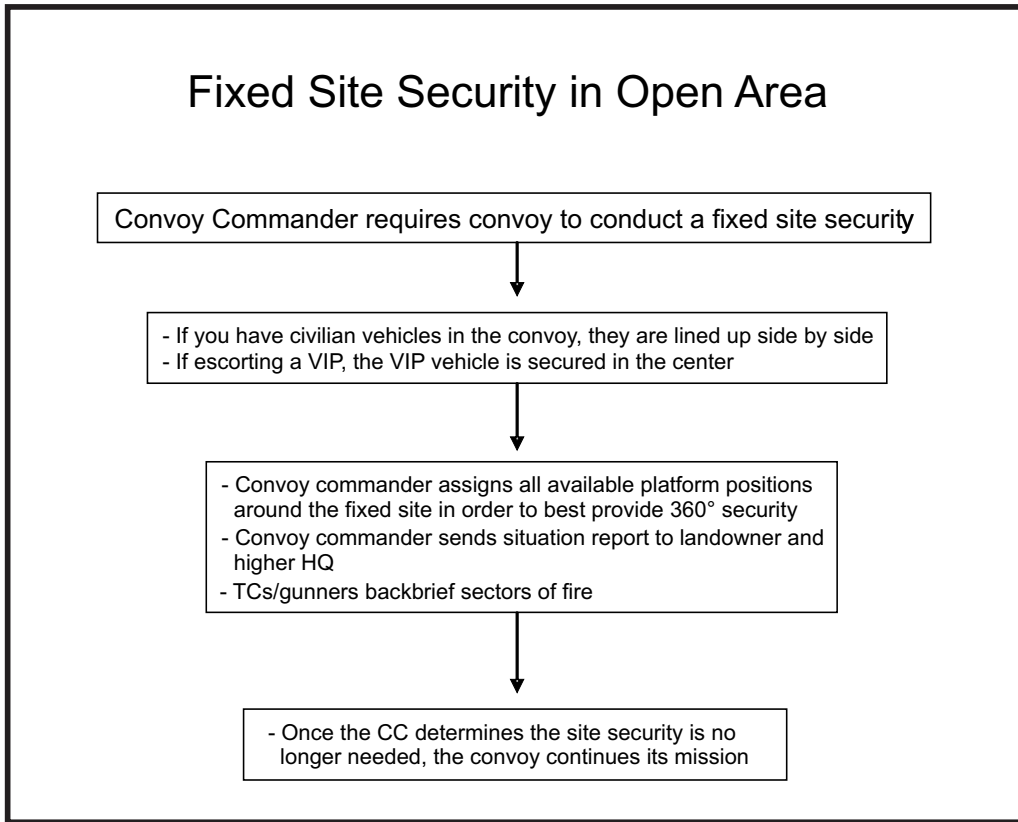

Figure 3-12

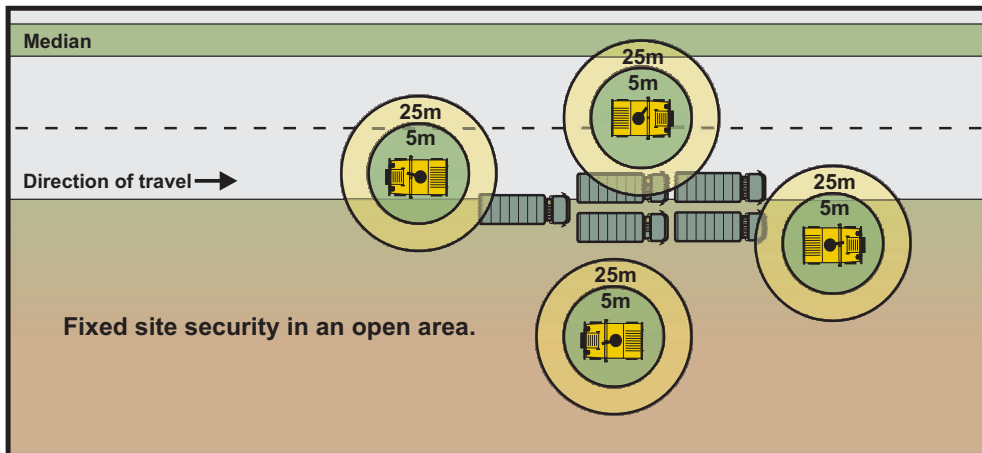

Figure 3-12a

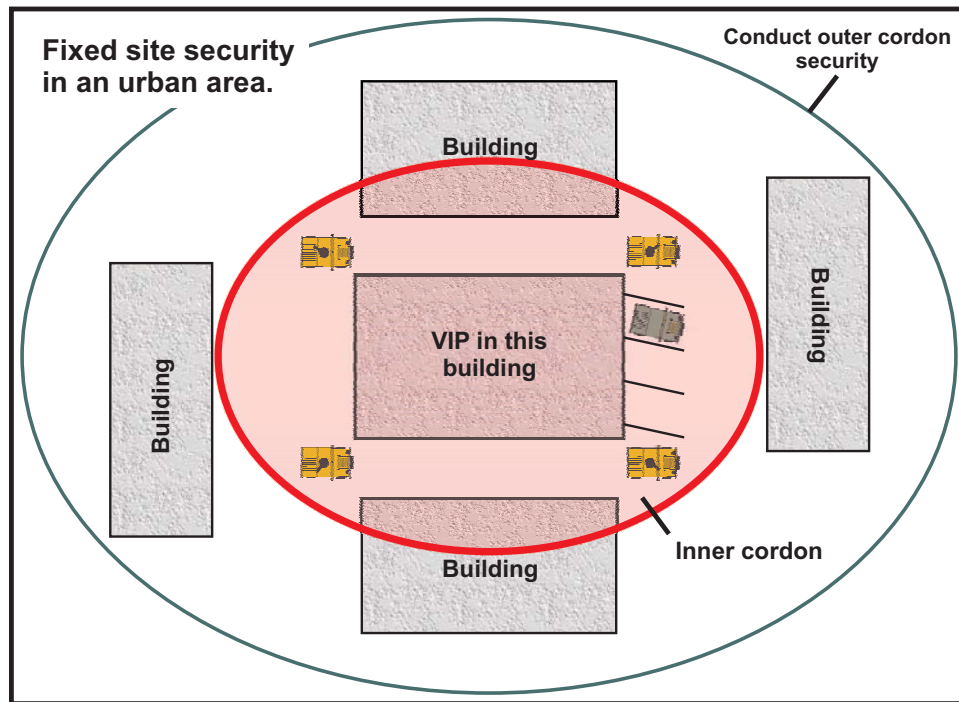

Figure 3-12b

m. **Securing the area around a building battle drill.** Gun trucks from the convoy will form an outer security around a building or area where a meeting may take place. This task is conducted regardless if security is already present. The intent is to achieve a 360 degree view of vehicles or pedestrians coming close to the secured location. The gun trucks must block the roads or avenues of approach leading into the area and scan for any VBIEDs or snipers on buildings or structures around the immediate area. Situations that might require security around a building include town meetings, escorting of VIPs to a conference, following up with local police, dropping off goods to schools or hospitals, or escorting civil affairs units conducting public relations with the community. Soldiers in the gun trucks shall report their location to the CC to confirm location and sectors of fire. Security remains in place until the mission is complete.

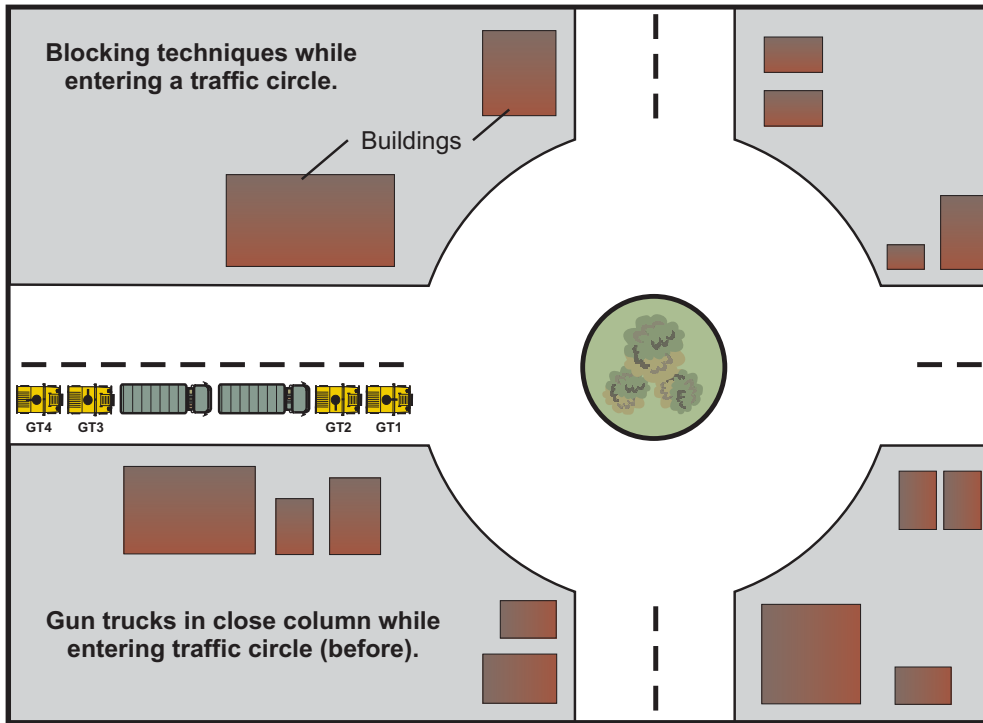

Figure 3-13a

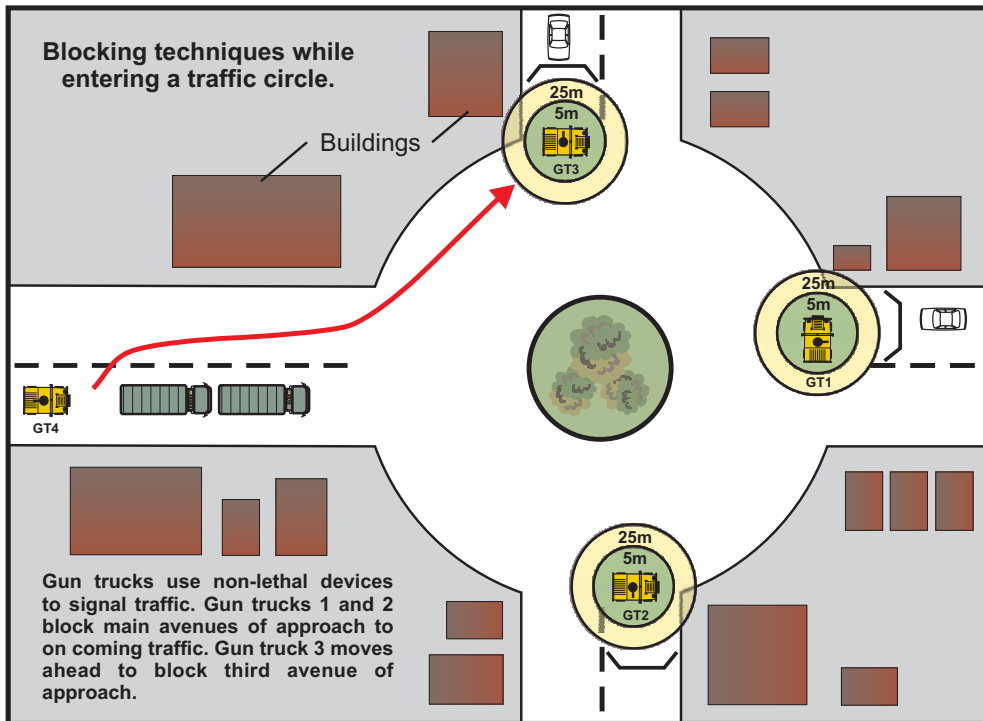

Figure 3-13b

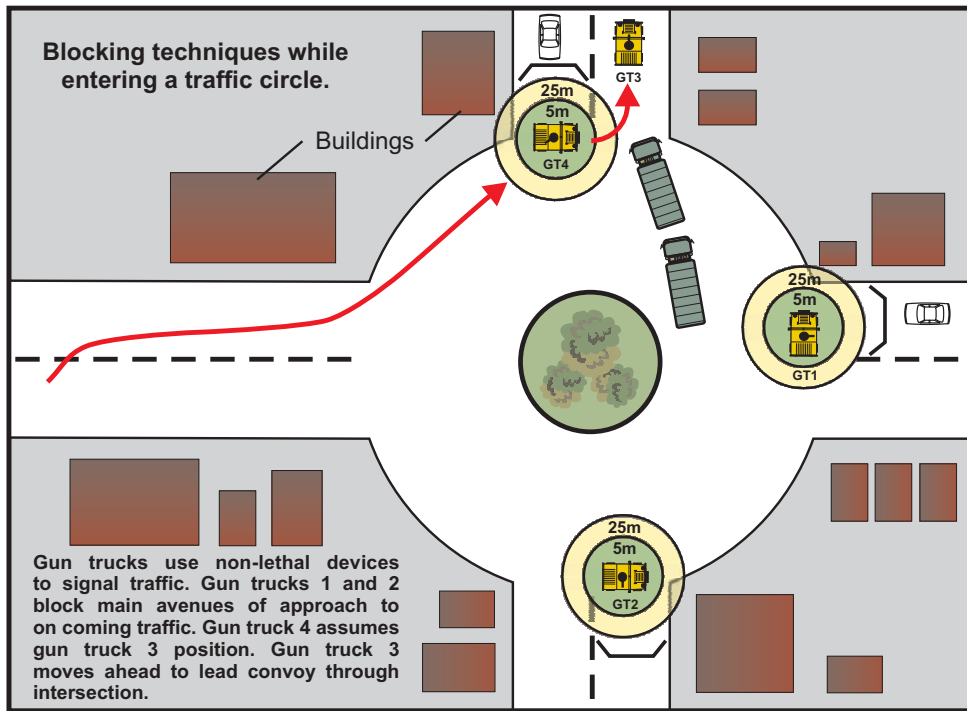

Figure 3-13c

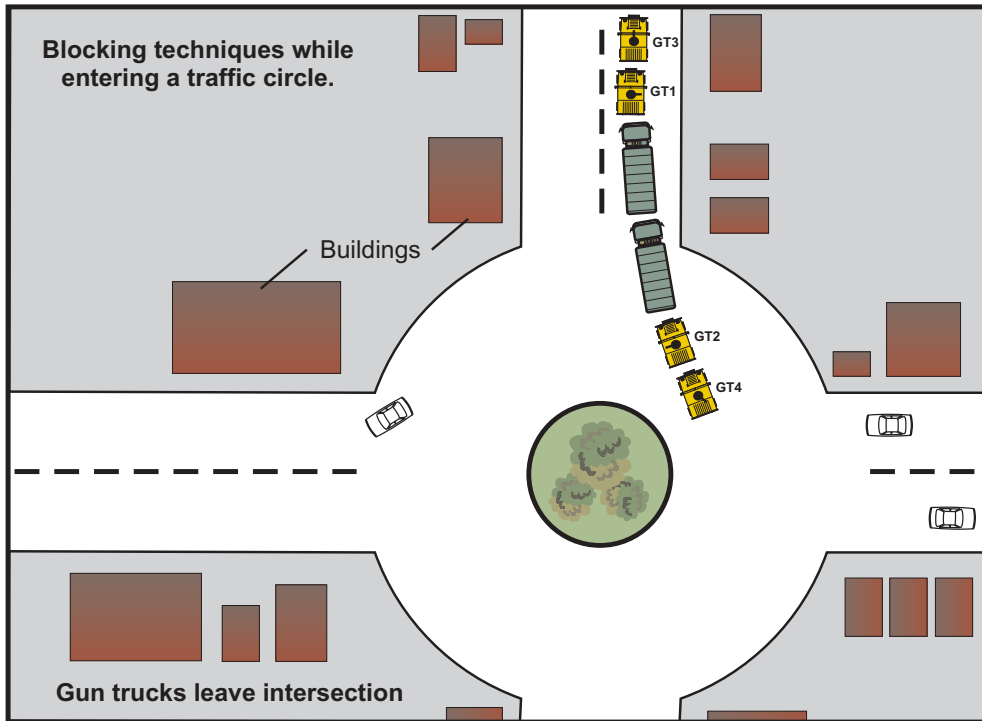

Figure 3-13d

n. **Blocking techniques: traffic circle, intersection, on/off ramp:**

- **Traffic circle.** When conducting convoy operations through a congested traffic circle, Soldiers in the lead gun truck shall use non-lethal means to alert the traffic to move so that the convoy can pass. Non-lethal means that can be used include spotlights, sirens, and lasers. In a logistical convoy, gun trucks should maneuver to block all roads entering the circle, allowing all trucks to enter and exit the traffic circle without interference from local traffic. The convoy intervals may be shortened to prevent civilian vehicles from entering convoys due to increased traffic. If Iraqi police are controlling the traffic circle, allow them to stop traffic to facilitate the convoy's passage. Every attempt should be made to follow the local traffic laws.

Intersection blocking. When convoys are approaching an intersection, the CC directs a gun truck to maneuver around the convoy and position itself at the intersection to block traffic. The gun truck must be in position at the intersection before the convoy passes to prevent civilian traffic and possible VBIEDs from entering the convoy. Once all vehicles have cleared the intersection, the driver of the blocking gun truck notifies the CC that all vehicles have cleared the intersection and then resumes his position in the convoy. If there is more than one intersection, the CC designates which trucks will block each intersection. In the case of a large convoy, gun trucks may use relief in place to minimize time away from the convoy. The CC must remain aware of speed and may need to adjust it based on distance to intersections and the size of the convoy. It is not recommended that the front or rear gun trucks be used because of possible VBIEDs approaching the convoy. Convoys must use warning signs in the local language posted on gun trucks warning civilians not to enter or get close to a military convoy.

On/Off-ramp blocking. When conducting convoy operations and exiting using an on/off-ramp, the actions are similar to blocking at an intersection. When the convoy is approaching the on-ramp, a gun truck will maneuver around the convoy and position itself at the end of the on-ramp to block traffic. When the entire convoy has traveled past the on-ramp on to the next route of travel, the driver of the blocking gun truck notifies the CC that all vehicles have made it on to the new route. The blocking gun truck falls back into the convoy and continues to maintain security for the convoy. The same procedure is used when exiting an off-ramp.

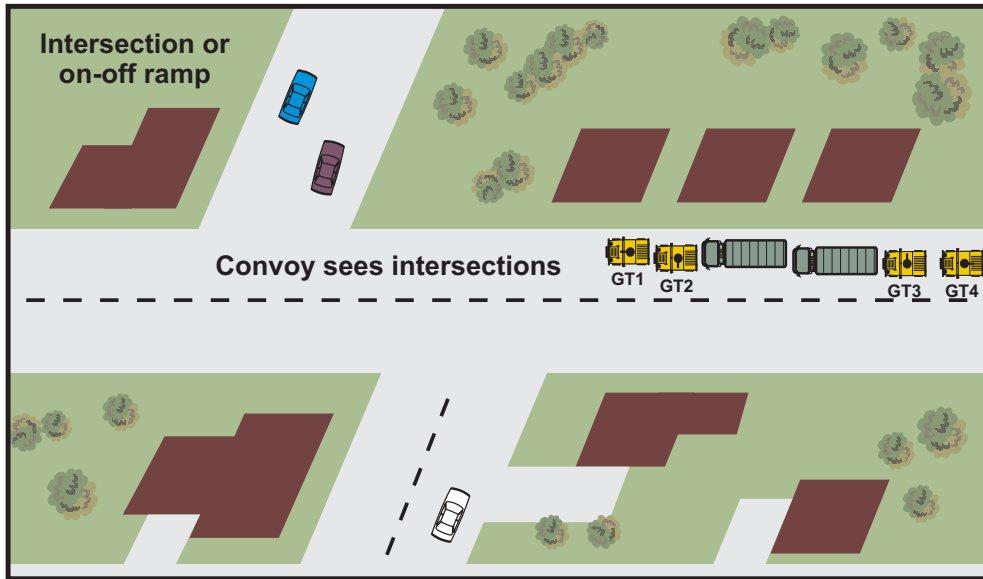

Figure 3-14a

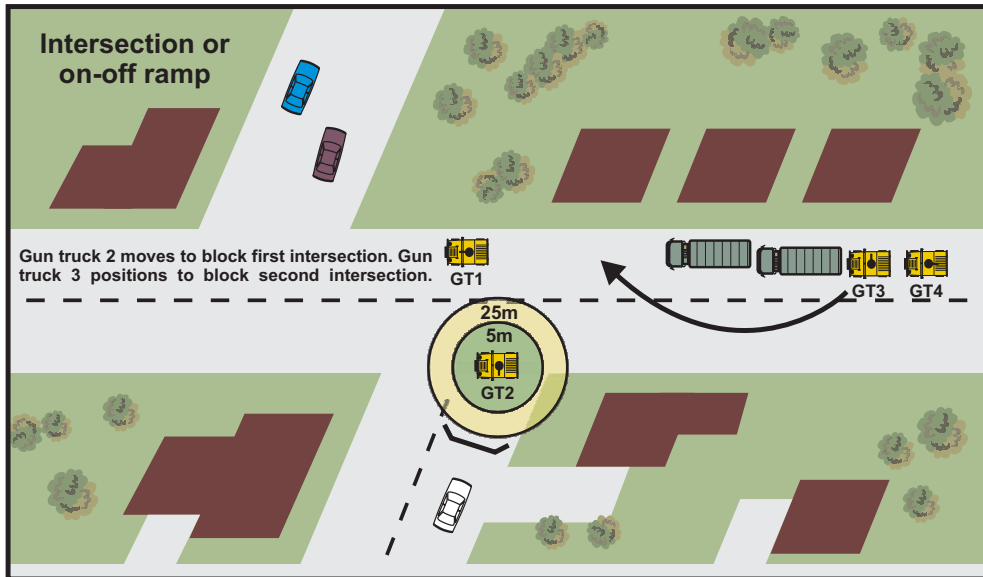

Figure 3-14b

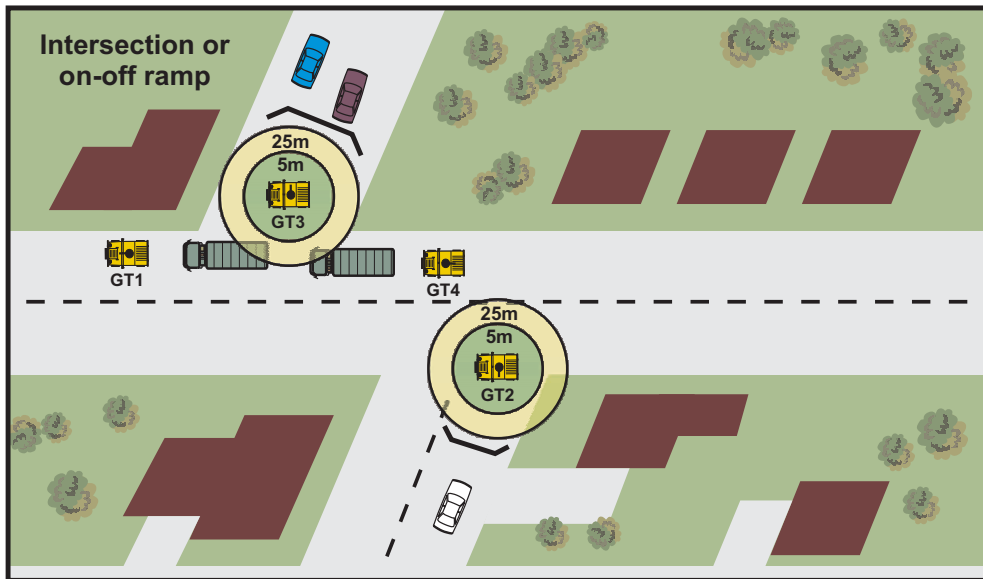

Figure 3-14c

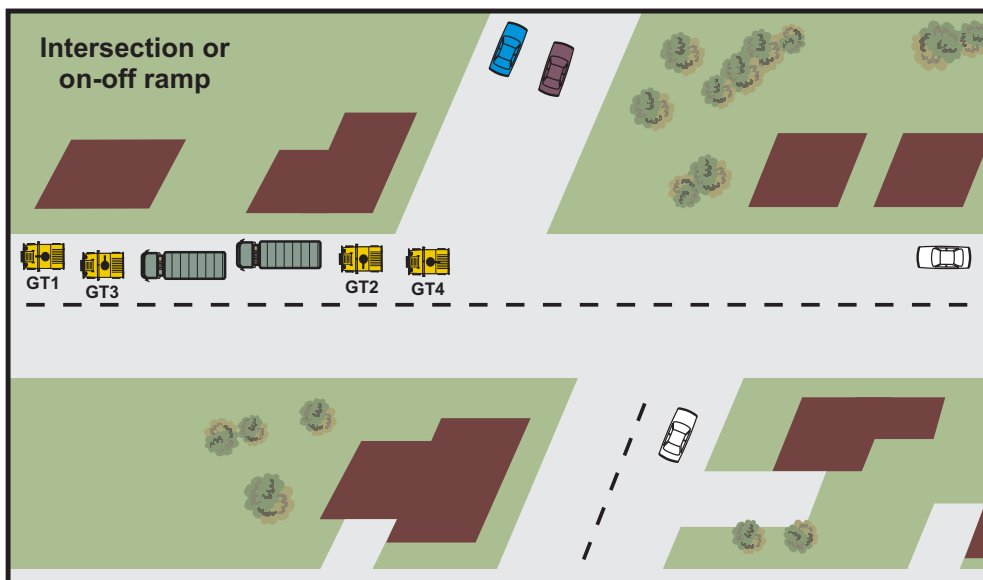

Figure 3-14d

- o. **Reloading ammunition battle drill.** When the gunner needs to reload a weapon, he announces “Reloading” so the TC can notify the nearest gun truck to cover. Once the TC coordinates coverage, he turns around and loosens any required ammunition the gunner may need and hands it to the gunner through the gunner’s ring mount. The gunner remains under cover while he secures and reloads the

additional ammunition. The driver assumes the responsibilities of radiotelephone operator while the TC hands the ammunition to the gunner. (**Note:** Some gunners have a back-up can of ammunition for quick reload welded in close proximity to their area, usually on the inside wall of the up-armored shields).

p. **CASEVAC battle drill.** If an ambulance is not available, a minimum of one vehicle (typically M1114) must be dedicated and equipped for CASEVAC. Ideally, the CASEVAC vehicle has space available to transport an injured Soldier on a spine board. Two designated vehicles (primary and alternate) are preferred. Aid and litter (A&L) teams will position themselves on the safe side of the vehicle and extract casualties and personnel as necessary. Treatment of casualties, except for emergency treatment to prevent loss of life, occurs only after the enemy is neutralized or after leaving kill zone. Personnel deploy obscuration measures if available. Utilizing cover and concealment, A&L teams evacuate all casualties with support of the gun trucks and other protective fires. Personnel will maintain position and suppression in contact zone and assist A&L teams as appropriate.

Casualty treatment begins upon pulling into the rally point. TC/driver begins buddy aid until casualty is stabilized or TC is relieved by a combat life-saver (CLS). The CLS immediately dismounts and scans assigned vehicles in search of casualties (four-way flashers should indicate location of casualties). Upon encountering a casualty, the CLS provides medical aid; once the casualty is stable, the CLS searches for others to assist. Triage is necessary during mass casualties and will be maintained by the assistant CC or designated Soldier. A&L teams will transport casualties with pre-positioned litters (according to load plan) and take them to the casualty collection point designated by the CC. CLS should focus on treatment of casualties and not be a part of the A&L team.

A&L teams will continue to assist with evacuation of casualties. The landing zone (LZ) team secures the LZ site with available gun trucks and stays clear of the flight path after establishing the LZ.

- Select and secure LZ 75-100 meters (downwind from the rally point).
- Clear objects from the LZ site.
- Prepare to display appropriate LZ signal/marking.
- Assist with the loading of casualties.

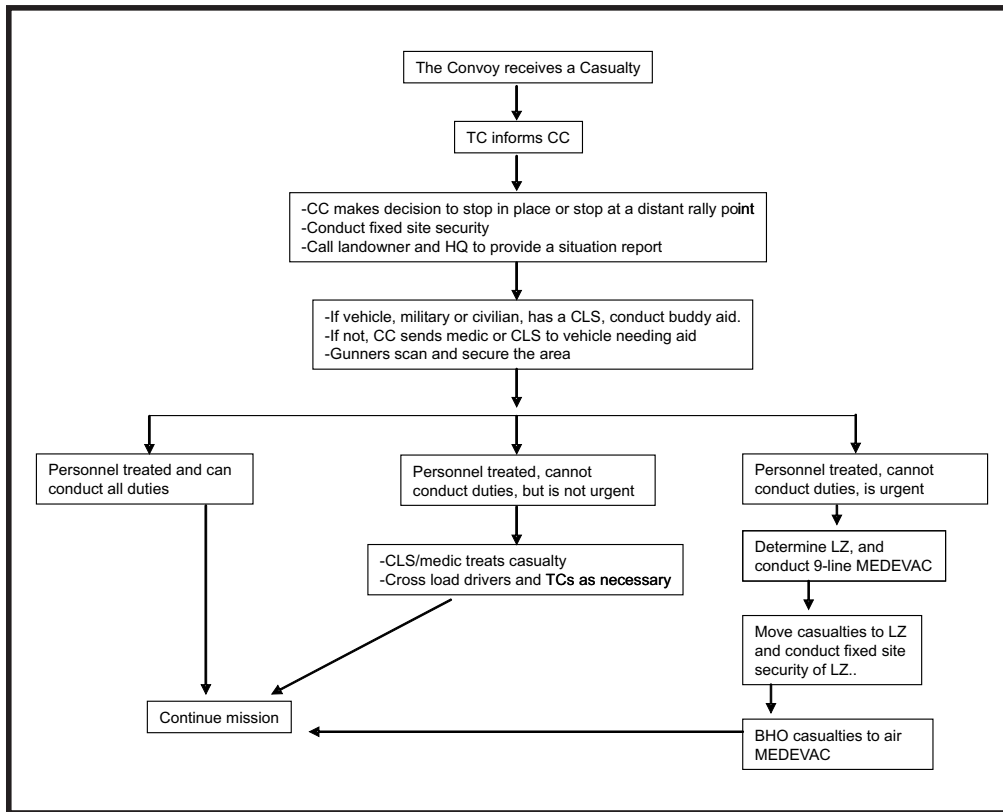

Figure 3-15: Casualty procedures

5. Protection Considerations

Prior to a convoy moving outside of a compound, leaders must be conscious of the threats found within the operating environment. Every mission must be thoroughly looked at and assessed for heightened risk factors and areas of increased enemy activity. The enemy is always improving techniques, as well as the sophistication of the employment methods. A thorough risk assessment prior to every mission helps mitigate dangers that might be encountered during the convoy.

The current biggest threat in OIF is IEDs. The enemy is finding better ways of disguising IEDs to blend in with the surroundings, employing IEDs in and out of rural areas, and continuously working on defeating protection systems.

In order to minimize the effects of IEDs, rocket propelled grenades, or snipers, any vehicle leaving a FOB must be up-armored. The personnel inside a platform have the protection of the vehicle, as well as their Interceptor Body Armor (IBA) system, Deltoid and Axillary Protector (DAP) system, Kevlar, and protective eye wear. These Soldiers are generally safe from most attacks.



Figure 3-16

The gunners, however, remain highly exposed. For this reason, modifications to platforms, as well as newly developed gear, provide gunners with additional protection.

The M1114 is the primary vehicle used by security forces. This platform offers more protection by providing a ring mount with armored shields around gunners. The reinforcement of the vehicles has significantly increased the chances of surviving a direct hit from some IEDs, VBIEDs, grenade attacks, and sniper fire.



In addition to shields, gunners now have the CPE, similar to bomb squad equipment. The CPE protects a gunner from sniper fire and shrapnel created by IEDs, which is the greatest threat for gunners.

Gunners wear a face shield which protects them from flying debris and SAF. Some units take an extra proactive measure by making it mandatory for the gunner to wear safety-approved eyewear beneath the CPE face shield.



Some vehicles are also modified with armor shields or ballistic shields which allow gunners to see and have protection from any flying hazards. The ballistic shields have an outer layer of Plexiglas that keeps the glass from getting scratched from everyday wear and tear.

Vehicles are equipped with multiple electrical devices that can aid the crew in identifying the location of suspected IEDs or remote devices (additional information classified); some devices can disrupt the functionality of common IEDs. Additionally, there is equipment that can help pinpoint the location of snipers (additional information classified). These new systems give convoys a better insight into danger areas along the route.



Additional safety measures include the plain eye modification to lead and tail gun trucks in convoys. These warning signs are effective deterrents against local traffic and civilians. The signs are in Arabic and English and warn local nationals to stay back 100 meters; if they get too close or do not move away from a moving convoy, they can be hit or in danger, as convoys move sporadically. In some areas, locals already know to pull off the road and put on their four-way flashers as the convoy passes.

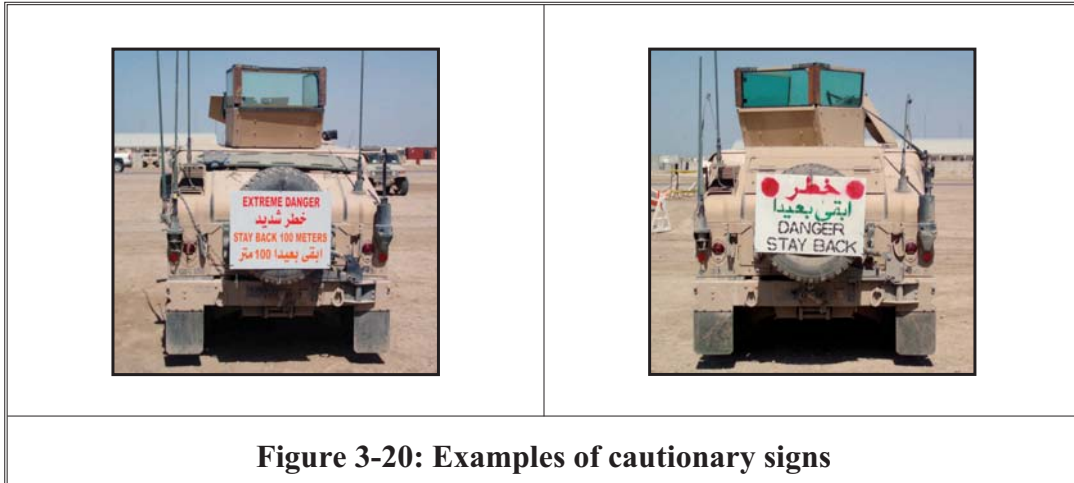

6. Weapons Employment

Weapons are to be distributed evenly to provide maximize firepower in all directions in case a situation arises that requires the convoy to defend itself.

The general consensus is that the heaviest and longer-range weapons should always be placed in the lead and trail gun trucks on convoys. Units must remember to have back-up weapons for close quarters combat, as they may drive through cities, towns, market areas, and crowded roadways.

The weapons must be ready and capable of suppressing a threat with equal force throughout the convoy. Machine guns of lesser caliber are used as back-up systems for gunners.

CCs must keep in mind that the weapon distribution and the distribution of extra ammunition must be closely monitored, as different weapons expend ammunition at differing rates.

a. Weapons choice considerations include the following:

- M9 handgun is the side arm most Soldiers carry and is used to engage threats less than 50 meters away. Maximum effective range 50 meters. Reference Field Manual (FM) 3-23.35, *Combat Training With Pistols, M9 and M11*. This publication supersedes FM 23-35, 10 October 1988.
- M16A2/M4 rifle is primarily used in close quarters mounted or dismounted, as it is a light weapon and easy to operate. Maximum range of 3600 meters and maximum effective range for point target is 550 meters, 800 meters for area target. —4 data is the same as M16A2. Reference FM 3-22.9, *Rifle Marksmanship M16A1, M16A2/3, M16A4 and M4 Carbine*. This publication supersedes FM 23-9, July 1989.
- M203 is used in populated area as it has numerous non-lethal munitions that can be used to open the way for a convoy or disperse a crowd. It is

also used to clear buildings or possible hiding locations of enemy insurgents. Maximum effective range area target 350 meters, point target 150 meters. Reference FM 3-22.3, *Stryker Gunnery*. This publication supersedes FM 23-31, 20 September 1994.

- M249 light machine gun crew-served weapon is used for close quarters where suppressive fire may be needed. Maximum range of 3600 meters, effective range 1000 meters. Reference FM 3-22.68, *Crew-Served Machine Guns, 5.56-mm and 7.62-mm*. This publication supersedes FM 23-67.
- M240B is a medium machine gun used for long and short-range support and sometimes is used as main gun on gun trucks. The M-240B has an effective range of 3,725 meters, maximum effective range of 1,100 meters. Reference FM 3-22.68. This publication supersedes FM 23-67.
- M60 machine gun is used as a supplementary medium crew-served weapon throughout some convoys. The M60 has an effective range of 1,100 meters.
- M2 .50 caliber machine gun is used as main gun on most gun trucks for maximum stopping power in rural and urban area. The M2 offers single shot control, which minimizes collateral damage. Maximum range (approx.) 6,764 meters, effective range (approx.) 1,830 meters, area target 1,830 meters, single shot 1,500 meters. Reference FM 23-65, *Browning Machine Gun Caliber .50 HB, M2*. This publication supersedes FM 23-65, 19 May 1972, and TC 23-65-1, 19 September 1984.
- MK19 40-mm grenade machine gun, MOD 3 is used for long convoys where open areas or large obstacles obscure the location of the enemy. Maximum range 2,212 meters, maximum effective range 1,500 meters. Reference FM 3-22.27, *MK 19, 40-mm Grenade Machine Gun, MOD 3*. This publication supersedes FM 23-27, 27 December 1998.

7. Recovery Operations

Upon the receipt of the mission, the CC designates a primary and alternate recovery team from within the convoy. These teams are responsible for responding to a vehicle breakdown regardless of the cause. The recovery team has a tow bar that is capable of towing the largest vehicle in the convoy. A general mechanic tools kit and the necessary tools, chains, and connecting devices vary for each convoy depending on vehicle types within the convoy.



Every vehicle should have some type of hasty recovery device attached permanently to the vehicle; for example, heavy-duty tow straps, air assault sling legs, or tow bars (see above). Prior to each convoy, the primary recovery team should rehearse hasty hook ups and non-hasty hook ups for every type of vehicle in the convoy. Rehearsals serve to identify any potential problems with connecting devices and ensure that correct tools and connecting device are present and positioned according to the load plan. The intent is to minimize the time necessary for a hasty recovery, thus reducing the time Soldiers spend outside the armored vehicles and time spent in the kill zone. The CC must develop an alternate seating plan for Soldiers whose vehicle becomes disabled to ensure they are not in the vehicle while it is towed. When conducting vehicle recoveries, similar vehicles should be used to recover like vehicles (i.e., 5 tons tow 5 tons).

If a vehicle becomes disabled due to enemy contact, every effort should be made to exit the danger area. If the enemy is identified, he must be engaged with crew-served weapons. When the situation permits, the primary recovery team starts recovery operations. If the primary recovery team's vehicle is disabled, then the secondary team assumes responsibility for recovery operations.

If the damaged vehicle is capable of being self-recovered then the primary recovery team will conduct a hasty hook up. If the vehicle is damaged beyond self recovery, then 360 degree security must be established. The CC contacts the local landowner for additional security and recovery assets. The damaged vehicle will be recovered to the closest FOB in the area.

8. Medical Considerations

In the event there is contact with the enemy or an accident, conduct 100 percent accountability of all personnel and their status. CLS and/or medics will help save Soldiers' lives. The actions taken after contact, including medical support, should be well-known prior to a squad leaving for a mission. SLs should rehearse A&L drills, specifically moving casualties inside the vehicles they will use. Add first aid practices and CLS recertification to unit training, as time permits. It is important to understand that mission comes first and all CLS are Warriors first; once the situation is neutralized, they can then quickly transition to focusing on buddy aid.

Below are additional first aid items not commonly found in CLS bags:

			
CAT tourniquet	Stingray poleless litter	EB02 emergency camo bandage	
			
QuikClot 3.5 oz single package		QuikClot ACS 2 sponge pack	
			
Black Hawk Rapid Flex medical litter		Black trauma kit with QuikClot, cinch tight bandage, and high volume gauze	

Figure 3-22

9. Battle Tracking

Battle tracking is the art of synchronizing the movement and actions of an ongoing mission and updating data received from the battlefield in order to provide appropriate support and keep track of the current status of the mission.

a. **Battle tracking tools.** The company tactical operations center (TOC) normally conducts the battle tracking. Tools used include maps and overlays, dry erase boards, BFT command station, SINCGARS (to monitor the higher HQ NET, company NET and sheriff’s NET), Secret Internet Protocol Router and Non-classified Internet Protocol Router access computers, tracking boards, and standard office supplies. At a minimum, the TOC map should reflect the boundaries, surrounding FOBs, company TOCs, Iraqi police stations/Iraqi Army camps, and the routes used. A journal records all radio traffic and status changes with convoys (DA Form 1594, Daily Staff Journal).

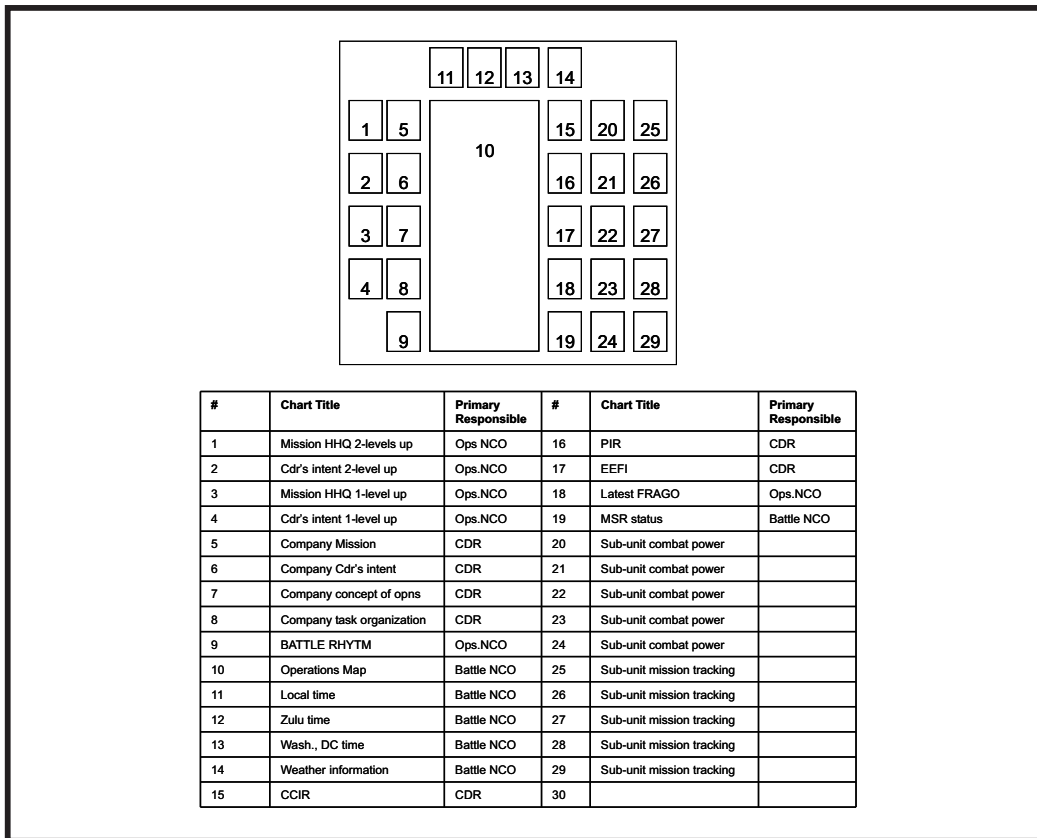

Figure 3-23: Sample TOC status board

b. **Battle tracking requirements.** The operations sergeant must identify what critical information is tracked based on the commander’s guidance. The operations sergeant is the coordination node for mission tracking, changes, and status. Some of the operations sergeant’s tracking responsibilities include:

- Updates charts hourly or when there is a change.
- Conducts prior coordination with landowners on behalf of convoys crossing boundaries during their mission.
- Monitors SINCGARS and BFT regularly for any updates or text messages sent from the convoy.
- Monitors HQ frequency, higher HQ frequency, and the sheriff’s NET.
- Updates all chart DTG with any changes.
- Saves, at a minimum, every battle update brief or nightly update brief and digital copies of charts for historical data.
- Ensures access to classified material is maintained and controlled.
- Sends appropriate intelligence summaries to CCs regularly during movement.
- Maintains historical 1594s in a secure location.

The TOC will continue to track the location and status of every convoy. It is critical that the convoy commander updates the TOC. Along with the location and mission status, the TOC also keeps track of the subordinate unit’s combat power. The forms below are examples for combat power tracking. A similar chart can be designed to designate the composition of the convoy if not a standard squad or platoon.

PLT	M1114 AUTH/OH	SINGARS AUTH/OH	M2 AUTH/OH	BFT AUTH/OH	TOTAL PLATFORMS AUTH/OH
1	10/	20/	10/	10/	10/
2	10/	20/	10/	10/	10/
3	10/	20/	10/	10/	10/
4	10/	20/	10/	10/	10/
Total	40/	80/	40/	40/	40/

Table 3-2: Sample form of combat power tracking

Sub-Unit Combat Power																						
ELEMENT		SHOOT				MOVE				COMMO		NGT VSN		CLASS								
		MK-19	M249	M203	M16A2	M4	M9	M998	M1025	M1026	M1078	TRAILER	WTR TRLR	MK-19	SINGGARS	BFT	ANCD	Warlock	ANPVS-5	TVS-5	PVS-7B	
HQ PLATOON 1 Man _____ 2 Man _____ 3 Man _____ 4 Man _____	2nd Sqd																					I
	1st Sqd																					
1ST PLATOON 1 Man _____ 2 Man _____ 3 Man _____ 4 Man _____	2nd Sqd																					IV
	1st Sqd																					
2ND PLATOON 1 Man _____ 2 Man _____ 3 Man _____ 4 Man _____	2nd Sqd																					VII
	1st Sqd																					
3RD PLATOON 1 Man _____ 2 Man _____ 3 Man _____ 4 Man _____	2nd Sqd																					IX
	1st Sqd																					
4TH PLATOON 1 Man _____ 2 Man _____ 3 Man _____ 4 Man _____	2nd Sqd																					MISC
	1st Sqd																					

Figure 3-24

Chapter 4

Post Operations

1. Duties and Responsibilities

a. Squad leader (SL)/Convoy commander (CC)

- Ensures maintenance of vehicles and weapons is complete.
- Develops storyboards, using PowerPoint, and depicts any incidents that occurred (escalation of force, contact, accidents, etc.)
- Fills in a mission debrief report in Microsoft Word, one hour after mission is complete, and sends to the battalion S2.
- Conducts after action review (AAR) with the squad.
- Prepares for next mission.
- Provides post operations guidance to squad.
- Solicits post operations briefbacks from subordinate team leaders.

b. Truck commander (TC)/Team leader

- Clears all weapons when entering a forward operations base (FOB) (gunner first, then crew).
- Accounts for all sensitive items.
- Assists CC in completing the debrief/close-out report.
- Ensures vehicle is ready for future missions.
- Initiates rest plan.
- Supervises the completion of post operations requirements for team.

c. Gunner

- Clears all weapons and gets vehicle commander to verify before anyone leaves the vehicle.
- Maintains and cleans all assigned weapons.
- Maintains Cupola Protective Ensemble.
- Maintains ring mount and gunner armor.
- Informs TC of any significant observations or encounters witnessed during the mission.

d. Driver

- Conducts after-operations preventive maintenance checks and services (PMCS) on vehicles, cleans inside of vehicles, and updates 5988E, Equipment Inspection and Maintenance Worksheet.
- Wipes down and properly stores all communications systems.
- Ensures all communications are turned off.
- Informs SL of deadline deficiencies.
- Cleans personal weapon and gear.
- Clean any hazardous material (HAZMAT) spills; emplaces drip pans.
- Refuels vehicle and ensures vehicle is ready for future missions.
- Ensures services are scheduled and completed in accordance with the directed service schedule.
- Cleans the vehicle (inside and out) upon completion of every mission.
- Performs spot painting as necessary to mitigate rusting.
- Changes tires and checks that spare tire is serviceable and on the vehicle.

2. Closure Report

The intent of a closure report is to identify convoy logistical issues and to provide insight to facilitate success for future missions. The closure report is submitted after the convoy AAR is complete. Often a unit combines the closure report with the debrief report that is turned into the S2. The closure report covers the following:

- Maintenance issues for vehicles, communications systems, digital equipment, weapon systems, and personal gear.
- The amount of ammunitions expended.
- Any field loss items during mission.
- Need for replenished supplies.
- Significant AAR comments discussed after the mission.
- Route information (new construction sites, congested areas, etc.).

3. Debrief

The debrief is given to the battalion S2 in order to capture any possible trends in enemy activity, as well as designate danger areas for friendly units. All Soldiers should be on the lookout for changes in the operating environment and local area.

Units in support of Operation Iraqi Freedom normally fill in a Microsoft Word document with pertinent information requested by the battalion S2. Below is an example of a debrief report sent up by the SL:

A: Date-time-Group (DTG)	
B1: Mission type	
B2: Mission	
C: Unit	
D: Convoy commander	
E: Number of vehicles and types	
F: Number of personnel	
G1: DTG Start Point (SP)	
G2: DTG Release Point (RP)	
H: Destination and grid	
I1: Route used on return trip	
I2: Route to objective used	
I3: Route intelligence updates (friendly/enemy)	
J: Map corrections (grids, buildings, routes)	
K: Terrain description	
L: Photos taken (buildings, locations, etc.)	
M: People contacted	
N: Enemy in area	
O1: Enemy contact (to include small arms fire [SAF], artillery, improvised explosive device [IED], vehicle borne improvised explosive device [VBIED])	
O2: Battle Damage Assessment (BDA)	
O3: Friendly wounded in action (WIA)/killed in action (KIA)	
P1: Ammunition expended. Why?	
P2: M4 rounds expended	
P2: M9 rounds expended	
P3: M249 rounds expended	
P4: MK19 rounds expended	
P5: M2 rounds expended	

P6: Pyrotechnics expended	
P7: Buckshot rounds expended	
P8: Non-lethal munitions used	
Q: Radio dead space/interference location	
R: Possible IED locations	
S: Significant road construction or congested areas	
T: Any other significant events	

Table 4-1

4. After Action Review (AAR)

An AAR is a professional discussion of an event, focused on performance standards, which enables Soldiers to discover what happened, why it happened, and how to sustain strengths and improve on weaknesses. It is a tool that leaders and units can use to get the maximum benefit from every mission or task.

An AAR must be conducted by the CC after every mission. The lessons learned in these AARs help units improve for the next mission and assist units in finding better methods to defeat adversaries. The enemy is adapting to coalition tactics, techniques, and procedures (TTP); it is important that units discuss and document lessons learned from each mission in order to update TTP. Leaders should be familiar with TC 25-20, *Leaders Guide to After Action Review*. Areas to cover include:

- Enemy activity, significant activities, and route conditions.
- Timeline.
- Any observations made by Soldiers in reference to the route, traffic flow, civilian activities.
- New TTP that proved effective (i.e., emplacement of weapons and countermeasures against enemy contact).
- Old TTP that are ineffective (include administrative and logistical requirements).

5. Maintenance

Perform after-maintenance checks designated on the appropriate schedule for vehicles. If any vehicles or equipment are due for services, be sure it is scheduled, and parts are on hand (or at least ordered). Conduct quality assurance (QA) and quality control (QC) on vehicles at least once a month to mitigate any future problems. (See Annex F for QA/QC checklist).

If a vehicle has sustained damage from an improvised explosive device (IED) or other forms of enemy contact, take appropriate actions to get the vehicle fixed. See following flow chart.

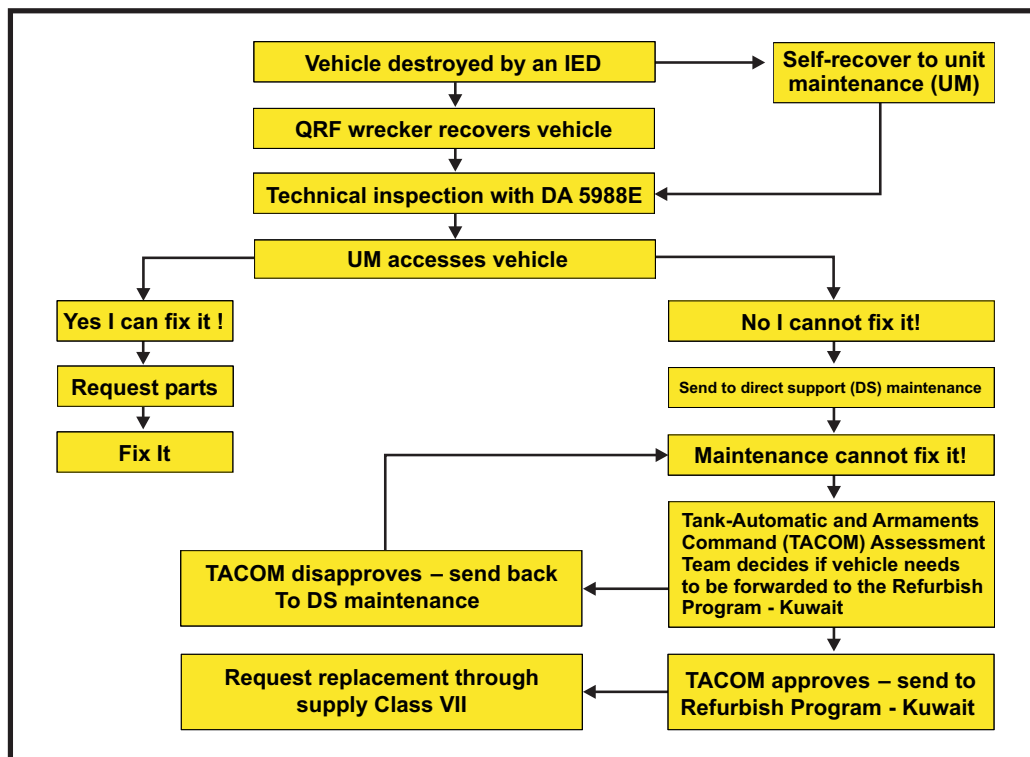

Figure 4-1: Vehicle repair sequence

Ensure after-operations, conduct PMCS on communications equipment, digital devices, all weapon systems, and personal gear (i.e. chemical, biological, radiological, and nuclear gear, body armor, Kevlar, eye protection, etc.). The effort put into maintaining serviceability of equipment keeps Soldiers combat ready for all missions.

6. Killed in Action Considerations

a. **Actions.** In the event actions against adversaries result in the death of one or more Soldiers, there are several requirements that must be met in accordance with local standing operating procedures (SOP). Below are a few considerations:

- Once a report is received by the next higher headquarters, the radiotelephone operator or designated personnel (operations noncommissioned officer, first sergeant, or commander) should contact medical personnel for evacuation (casualty liaison team), military police for route escort, and appropriate personnel for mental health and trauma issues (chaplain, psychologist, combat stress team). The unit making the report should provide accurate information as to the status of all Soldiers within their convoy.

- Upon arrival and removal of any casualties, the casualty vehicle(s) must be secured so investigators are able to deduce what exactly happened during an attack. Securing vehicles allows Army investigators to learn from the failures and successes of the current armament, current TTP, as well as the enemy's methods of attack.
- When transferring a killed in action (KIA) Soldier out of the vehicle to another location (i.e., ambulance or casualty collection point), collect all body parts and personal items (including items in uniform pockets), put them in a tagged bag, and place them with the casualty. Whenever possible, Soldiers suffering from injuries should be transported separately from those KIA. Cordon off the area to help ensure transportation of the KIA is not delayed. Be sure bodies are covered by a blanket or equivalent cover.
- Soldiers handling casualties should wear gloves (rubber gloves should be part of the mass casualty kit). Once the initial investigation is complete, a thorough search of the affected areas should be conducted in order to collect any biohazard material. The local mobile Army surgical hospital should assist with the proper care of biohazard remnants.
- HAZMAT must be considered when a vehicle returns after contact. In the event a vehicle leaks, a HAZMAT kit can be used until the local HAZMAT team clears the location.
- It is important to get the unit back to work in order to refocus on the mission and renew/preserve morale.
- The unit commander must also notify the home station rear detachment commander of the casualty. The rear detachment commander should not act until contacted by the Regional Casualty Assistance Team. The unit commander must also reinforce the order that no Soldiers e-mail, call, or write home about the incident until the designated notification officer (designated by Regional Casualty Assistance Team) has had an opportunity to speak with the casualty's next of kin.

b. Administrative considerations. The unit commander also has numerous administrative requirements and considerations:

- Provide the local casualty liaison team an accurate report of what happened so the incident can be updated on the Defense Civilian Intelligence Personnel System (DSCIPS). As updates, changes, or further clarifications are made, supplemental reports must also be sent up via DSCIPS. Corps and Department of the Army (DA) can log into DSCIPS; DA Casualties will get the report; attain the appropriate DD93, Record of Emergency Data; and inform the appropriate Regional Casualty Assistance Team.
- The company/battery, battalion, and brigade commanders within any KIA Soldier's chain of command will each write a "letter of sympathy" for the next of kin. Copies of these letters will go to division and above via S1 channels. The commanding general (division and above) will write a "letter of condolence" to the next of kin.

- The Soldier's immediate commander will write "words of remembrance" to be given to the general officer attending the KIA Soldier's service. This document can be in bullet or paragraph format and generally contains comments made by friends and leaders who knew and worked closely with the KIA Soldier. The document should be sent up to the division G1 via administrative channels.
- The company commander, with assistance of the unit chaplain, should also start preparing a memorial service. Having a memorial SOP prior to deployment will alleviate last minute research; the Chaplain Corps is a good resource in this area.
- The company commander must promptly send up request for posthumous promotions through S1 channels. This is usually only approved for Soldiers who were eligible for promotion. Posthumous awards (i.e. combat award, the Purple Heart, and the Combat Action Badge) must be requested through the same channel. Additionally, service awards must be submitted as soon as possible in order to be presented along with other honors given to the Soldier and next of kin (usually during the funeral).
- If desired, the company commander may designate an escort for the remains. The escort is usually a family member, close friend, and/or a representative of the unit for the funeral. This request must be sent up through administrative channels prior to movement of the remains.

Obviously this is a grim subject; however, preparation in advance will best assist the unit and next of kin in the event of a death within the unit.

Annex A

Types of Convoys Escorted

General

The convoy escort mission shares many similarities to the structure of the U.S. military's convoy logistical patrol (CLP). The leadership of a CLP escorting TCN and U.S. contracted trucks need to be aware of many additional considerations. Depending on the threat level of a particular route, a CLP with as few as ten gun trucks may be responsible for the protection of as many as 90 TCN trucks, all driven by drivers who do not speak English. Whether the trucks escorted are driven by U.S. citizens or local nationals, a convoy commander (CC) can expect to have little or no prior coordination with the drivers of these vehicles before start point.

U.S. contracted trucks

Kellogg, Brown, and Root (KBR) trucks are the most commonly contracted U.S. trucks in Iraq. Many of the issues that arise with escorting TCN trucks do not apply to KBR truck drivers. The KBR drivers are usually well-organized and typically have internal communications with every one of their trucks. A senior employee among the KBR drivers usually equips the CC with a radio that will allow him to talk to the KBR truck drivers directly. In addition, because KBR truck drivers are U.S. citizens, the gun truck to KBR truck ratio is 1:5 and no more than 20 KBR trucks can travel in a convoy at a time, regardless of the number of gun trucks available. KBR truck drivers are noncombatants and are not allowed to carry personally owned weapons. Therefore, the CC of a CLP that is escorting KBR trucks has to modify tactics, techniques, and procedures in order to provide the maximum protection for all vehicles within the convoy.

Third Country National (TCN) trucks

Escort missions involving TCN trucks are, by far, the most challenging CLPs a CC will lead. CLPs escorting locally contracted trucks can have as many as ten TCN trucks for every one gun truck, with a maximum of 90 TCN trucks per convoy. When escorting TCN trucks, the CC assumes responsibility of every last one of the locally contracted trucks, as well as the lives of the drivers. However, especially in units newly arrived in Iraq, the convoy leadership instinctively wants to place all of their U.S. military vehicles next to each other for reasons of protecting the Soldiers of their unit. A CC of a ten gun truck CLP escorting 90 TCN trucks who places five gun trucks in the lead and five gun trucks in the rear element will quickly discover that he cannot maintain positive control of his convoy. Here are some after action report comments from CCs in the 71st Corps Support Battalion pertaining to common actions of the TCN truck drivers:

- TCN truck drivers will stop (no matter where they are) if they lose sight of the vehicle in front of them. They will not move their truck again until

a U.S. military vehicle pulls in front of them and escorts them back to the rear of the convoy.

- The TCN truck drivers usually have friends and family within the convoy, and they will travel together and hook up to each other when vehicles break down. However, truck drivers who have no family or friends in the convoy will be left behind if their truck breaks down.
- Out of fear they will be left behind, the TCN truckers will continue to pass each other when the convoy slows down. When the convoy comes to a stop, the trucks will continue to try to pass one another until all lanes of the road are blocked.
- If a convoy stops for more than five minutes, a majority of the TCN truck drivers will get out of their trucks, while the remaining few will fall asleep.

Annex B

M2 Machine Gun Components

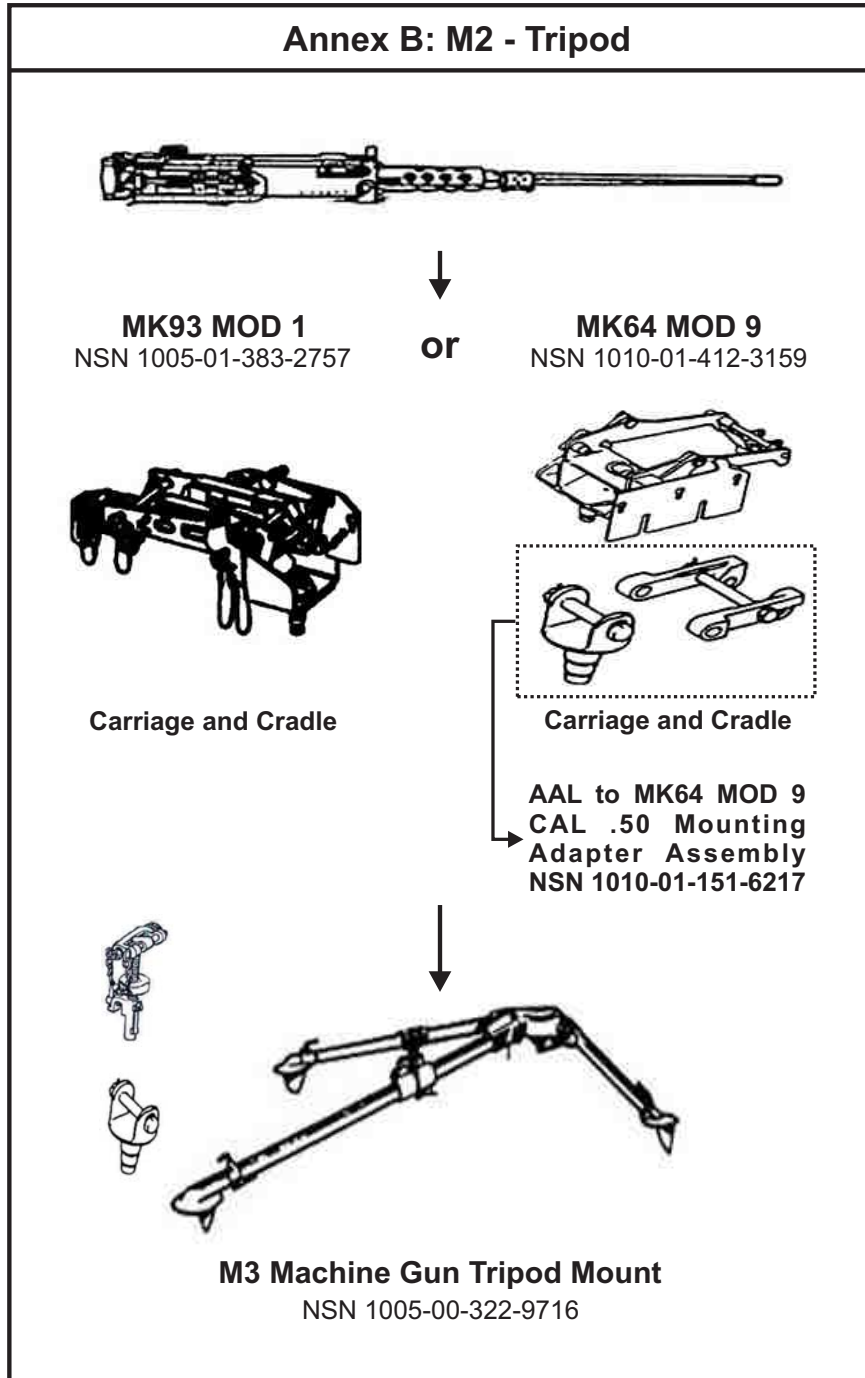

Figure Annex B-1

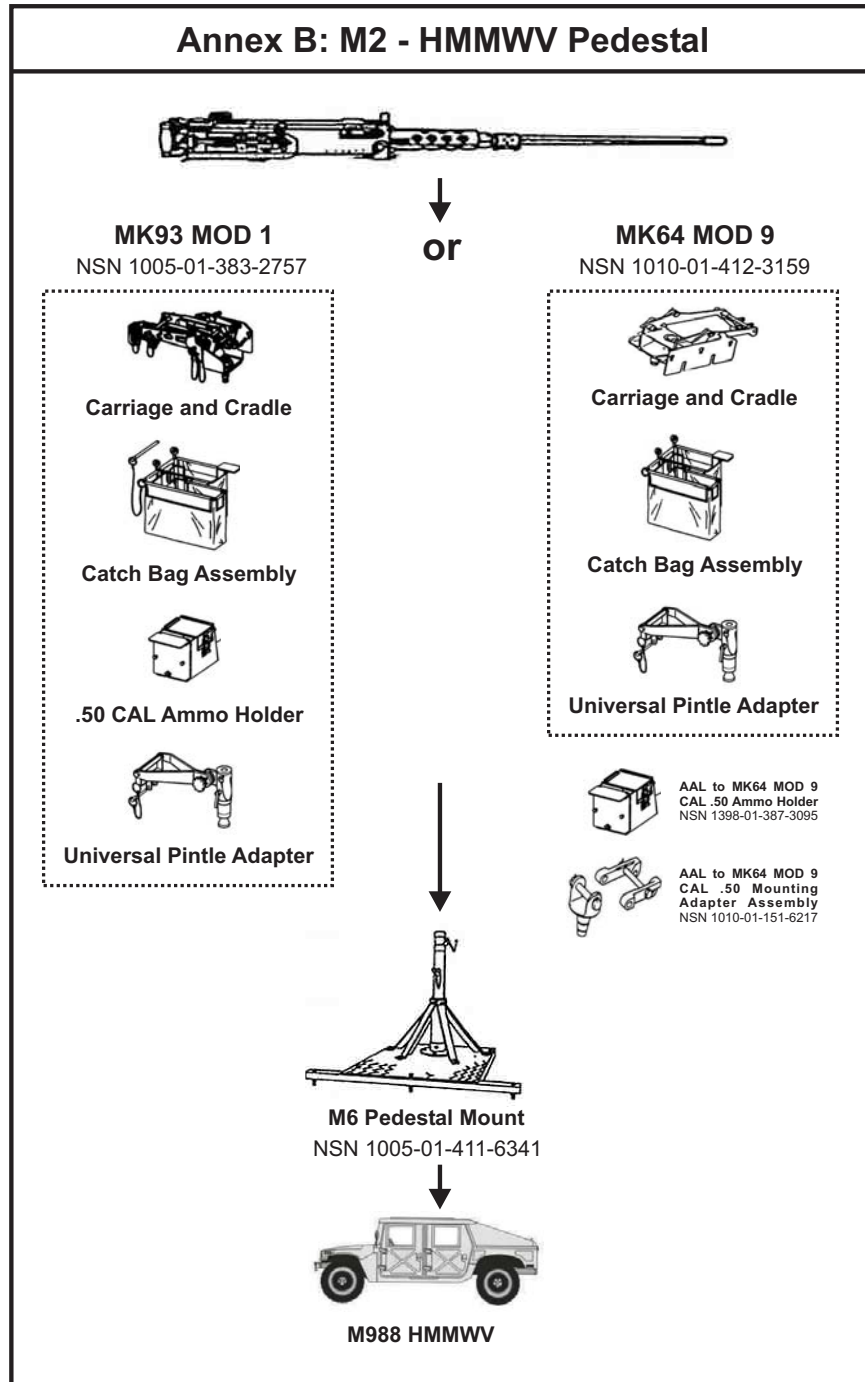

Figure Annex B-2

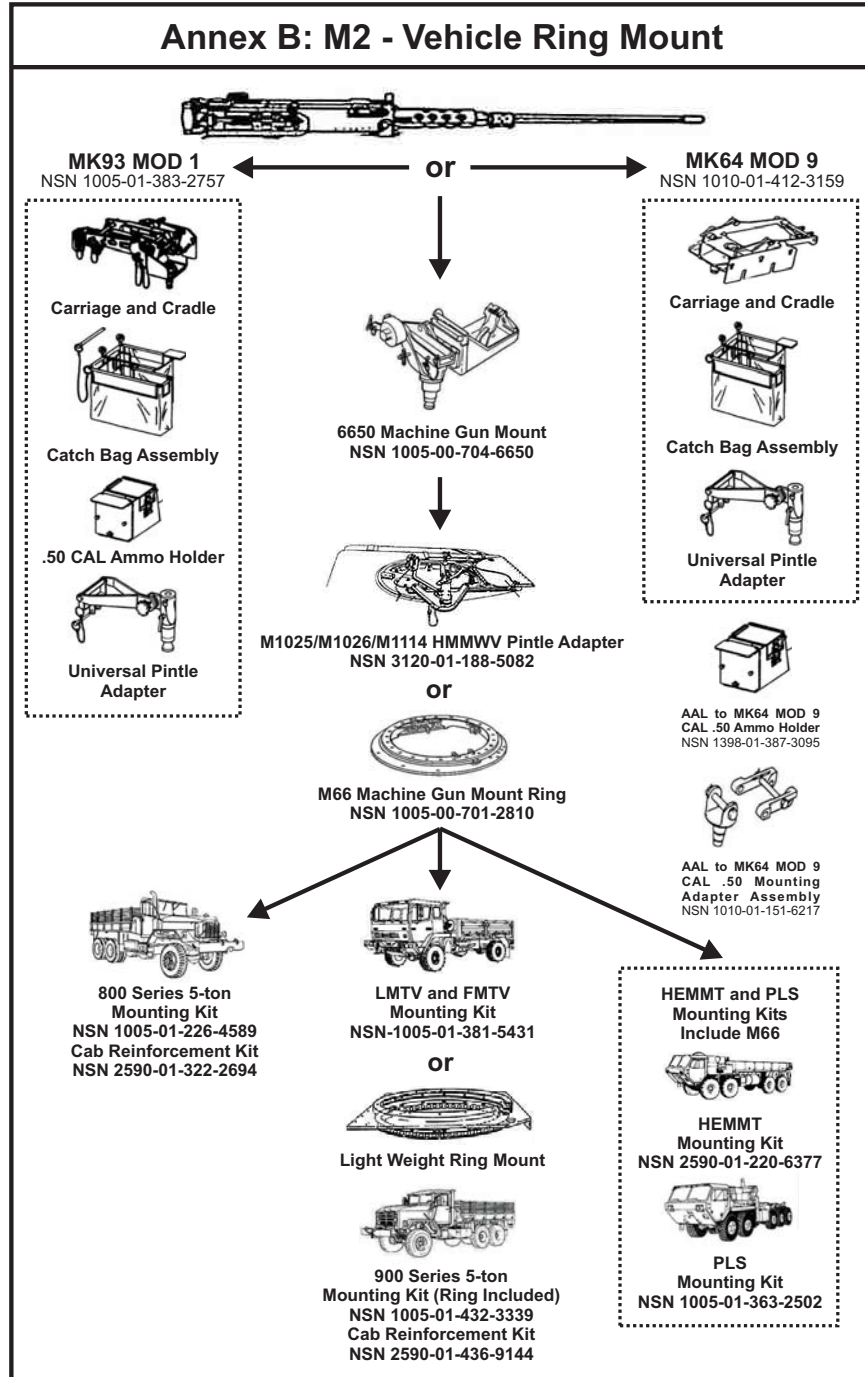

Figure Annex B-3

M2 .50 caliber mounting accessories

MK93 MOD 1 NSN: 1005013832757

MK MOD 9 NSN: 1010014123159

6650 Machine gun mount NSN: 105007046650

M1025/M1026/M1114 HMMWV pintle adapter NSN: 3120011885082

M66 machine gun mount ring NSN: 1005007012810

800 series 5 ton mounting kit NSN: 1005012264589

Cab reinforcement kit NSN: 2590013222694

Light medium tactical vehicles (LMTV) and family of medium tactical vehicles (FMTV) mounting kit NSN: 1005013815431

Heavy expanded mobility tactical truck (HEMTT) mounting kit NSN: 2590012206377 (includes M66 ring mount)

Palletized Load System (PLS) mounting kit NSN: 1005013632502

Lightweight ring mounting kit for 900 series 5 ton NSN: 1005014323339

Cab reinforcement kit NSN: 2590014369144

Annex C

M240B Machine Gun Components

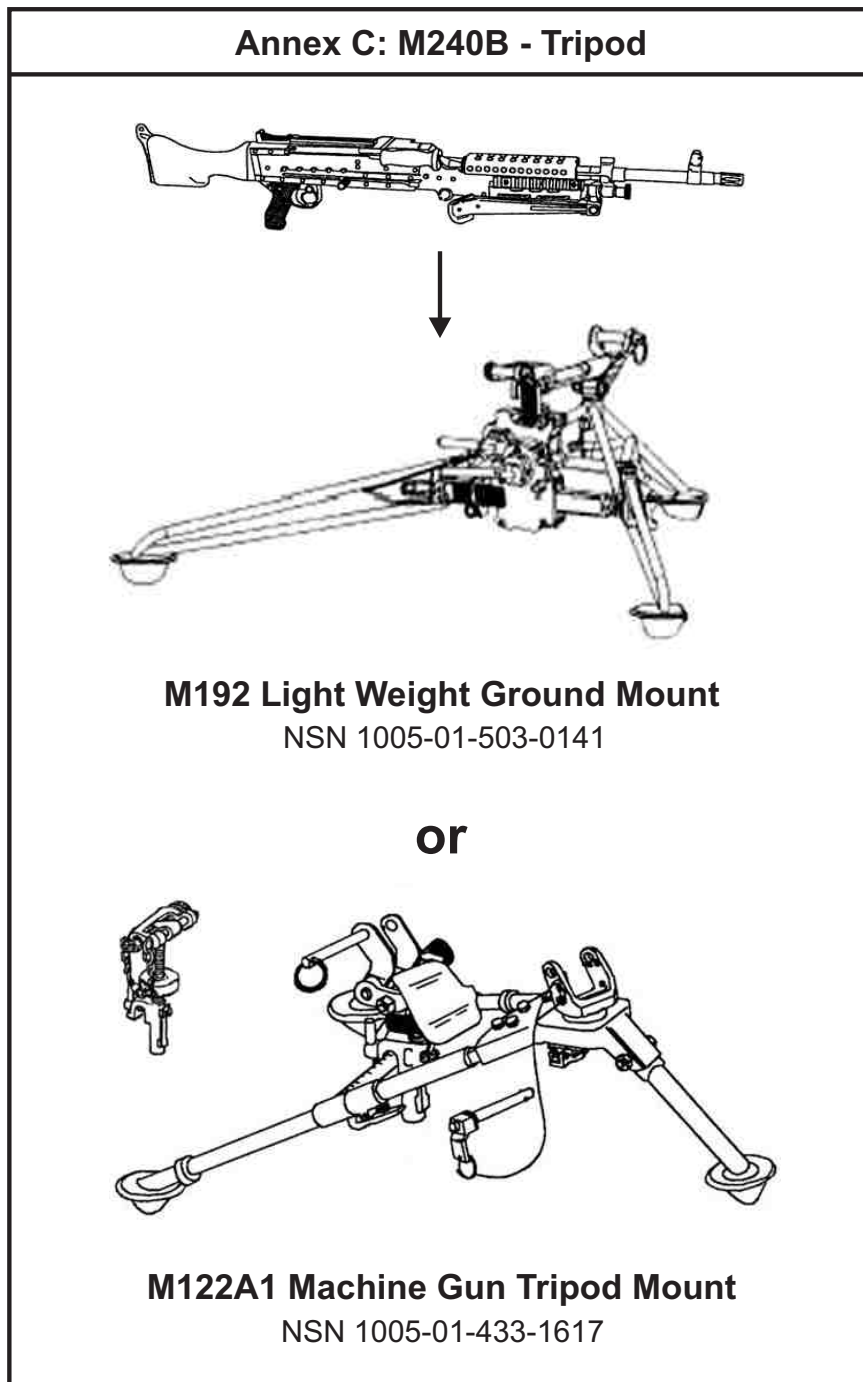

Figure Annex C-1

M240B mounting accessories

Ammunition adapter bracket assembly NSN:1005014318324

Deflector kit NSN:1005014680552

M197 machine gun mount NSN:10050114134098

M1025/M1026/M1114 HMMWV pintle adapter NSN: 3120011885082

M66 machine gun mount ring NSN: 1005007012810

800 series 5 ton mounting kit NSN: 1005012264589

Cab reinforcement kit NSN: 2590013222694

Light medium tactical vehicle (LMTV) and family of medium tactical vehicles (FMTV) mounting kit NSN: 1005013815431

Heavy expended mobility tactical truck (HEMTT) mounting kit NSN: 2590012206377 (includes M66 ring mount)

Palletized Load System (PLS) mounting kit NSN: 1005013632502

Lightweight ring mounting kit for 900 series 5 ton NSN: 1005014323339

Cab reinforcement kit NSN: 2590014369144

Annex D

M249 Machine Gun Components

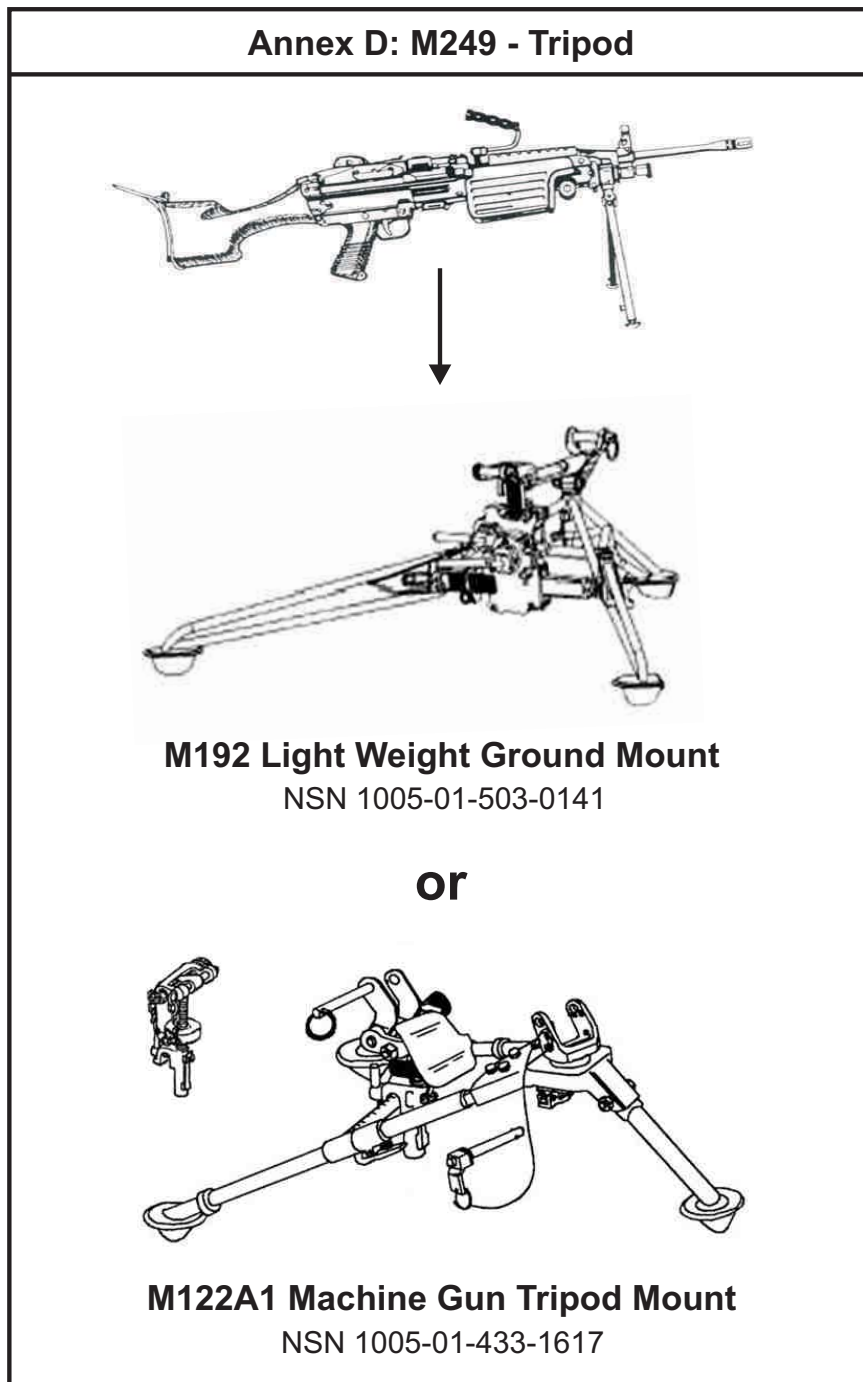

Figure Annex D-1

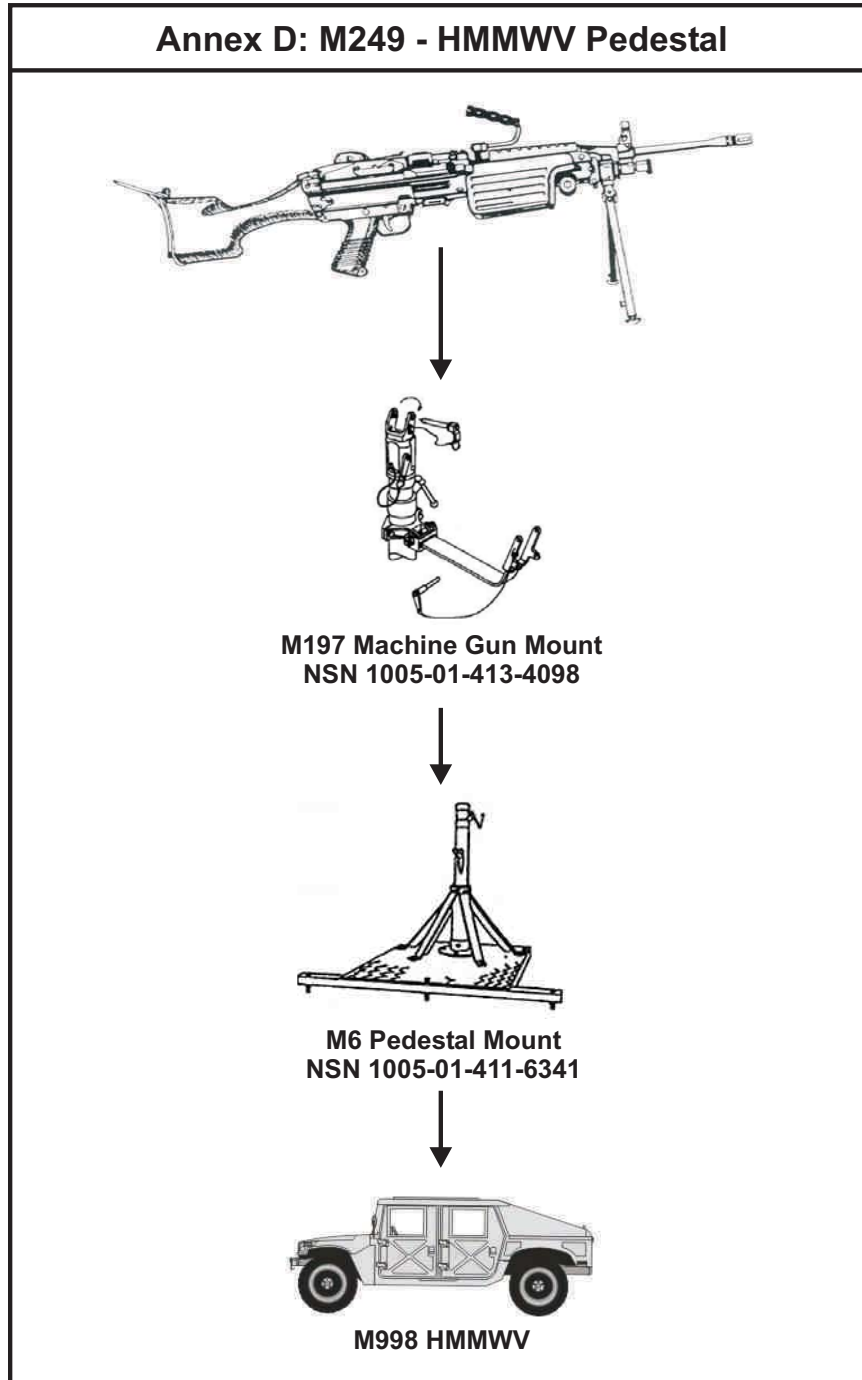

Figure Annex D-2

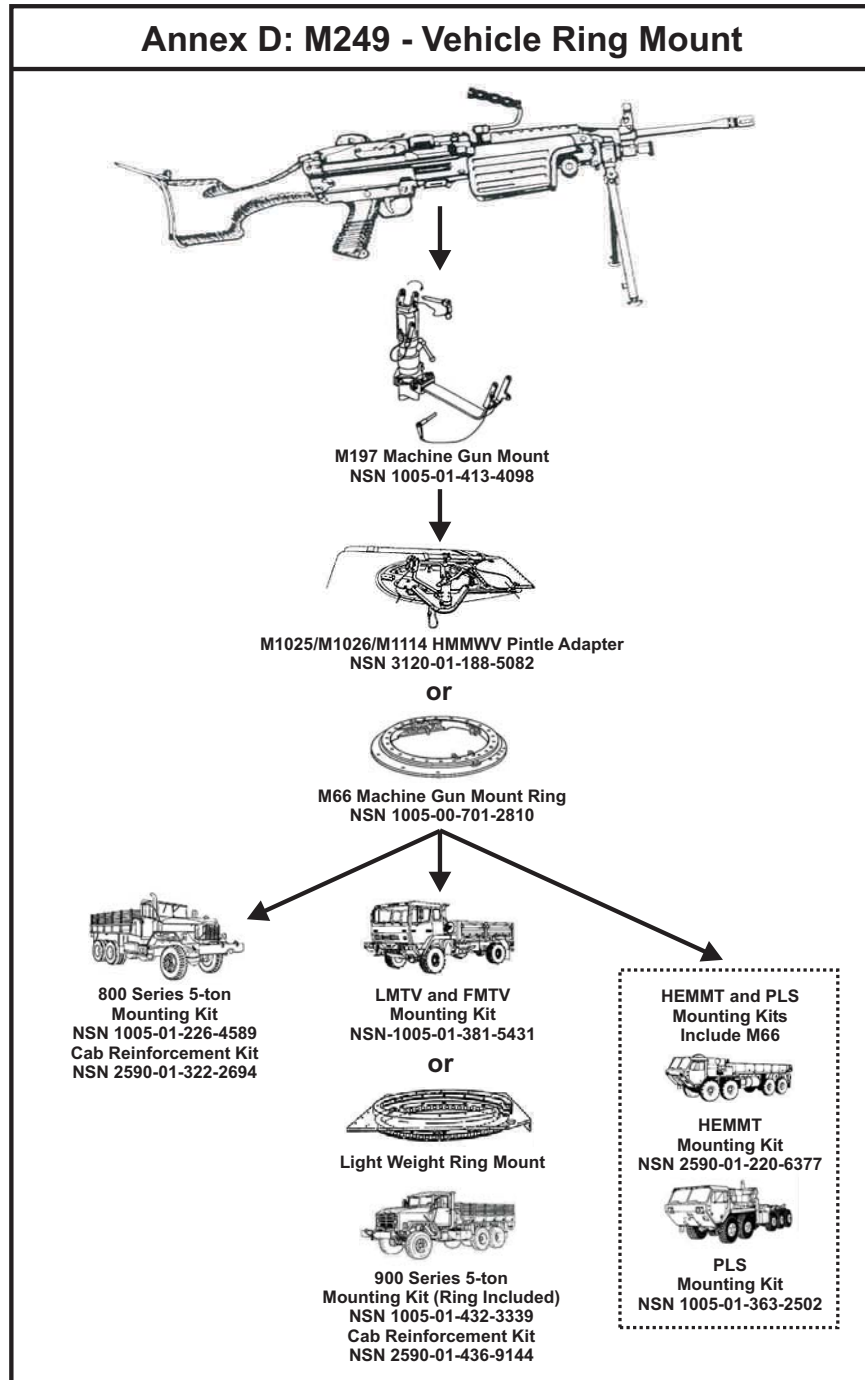

Figure Annex D-3

M249 mounting accessories

Ammo adapter bracket assembly NSN:1005014318324

Deflector kit NSN:1005014680552

M197 machine gun mount NSN:10050114134098

M1025/M1026/M1114 HMMWV pintle adapter NSN: 3120011885082

M66 machinegun mount ring NSN:1005007012810

800 series 5 ton mounting kit NSN:1005012264589

Cab reinforcement kit NSN: 2590013222694

Light medium tactical vehicle (LMTV) and family of medium tactical vehicles (FMTV) mounting kit NSN:1005013815431

Heavy expended mobility tactical truck (HEMTT) mounting kit NSN: 2590012206377 (includes M66 ring mount)

Palletized Load System (PLS) mounting kit NSN:1005013632502

Lightweight ring mounting kit for 900 series 5 ton NSN:1005014323339

Cab reinforcement kit NSN: 2590014369144

Annex E

MK19 Machine Gun Components

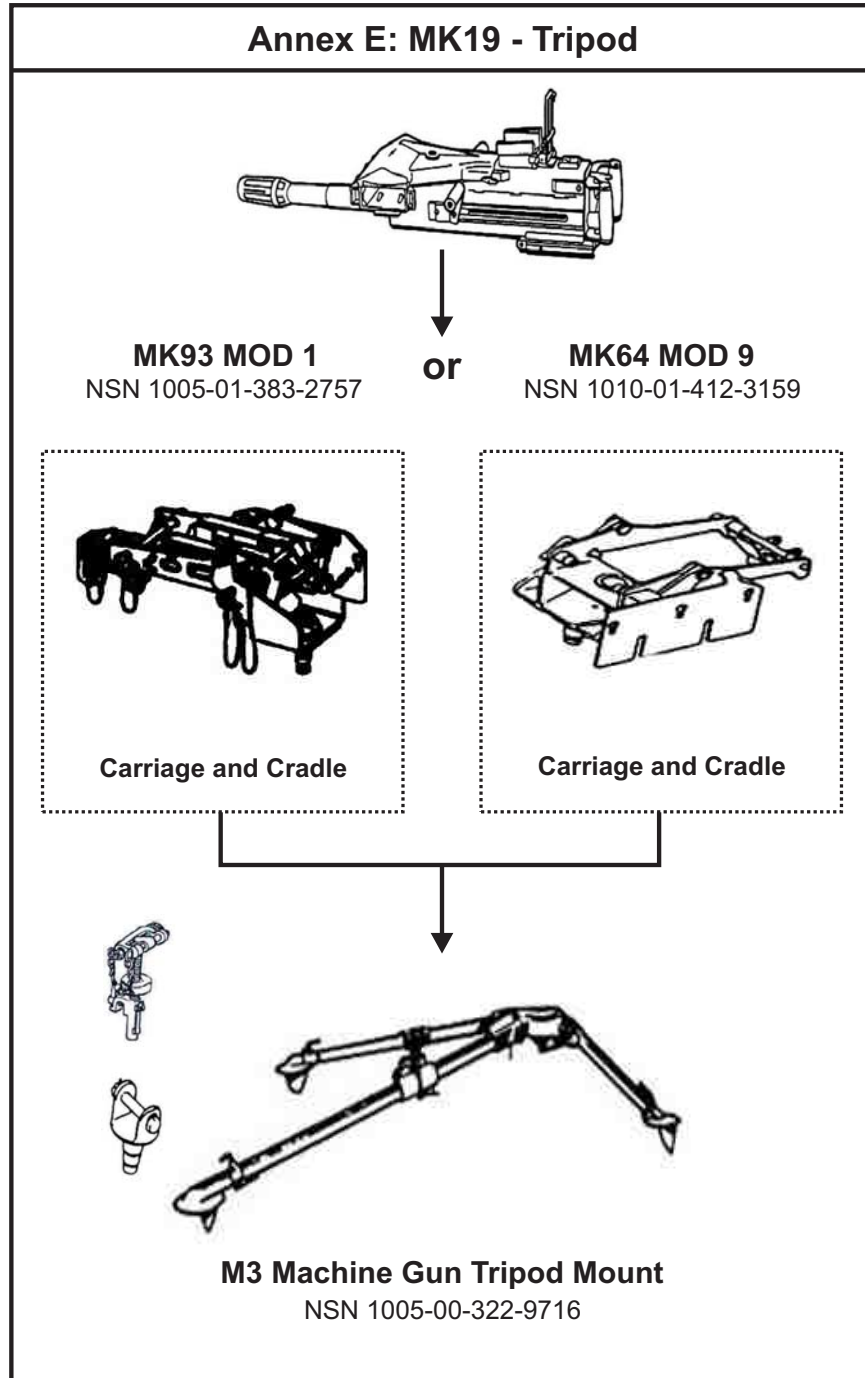

Figure Annex E-1

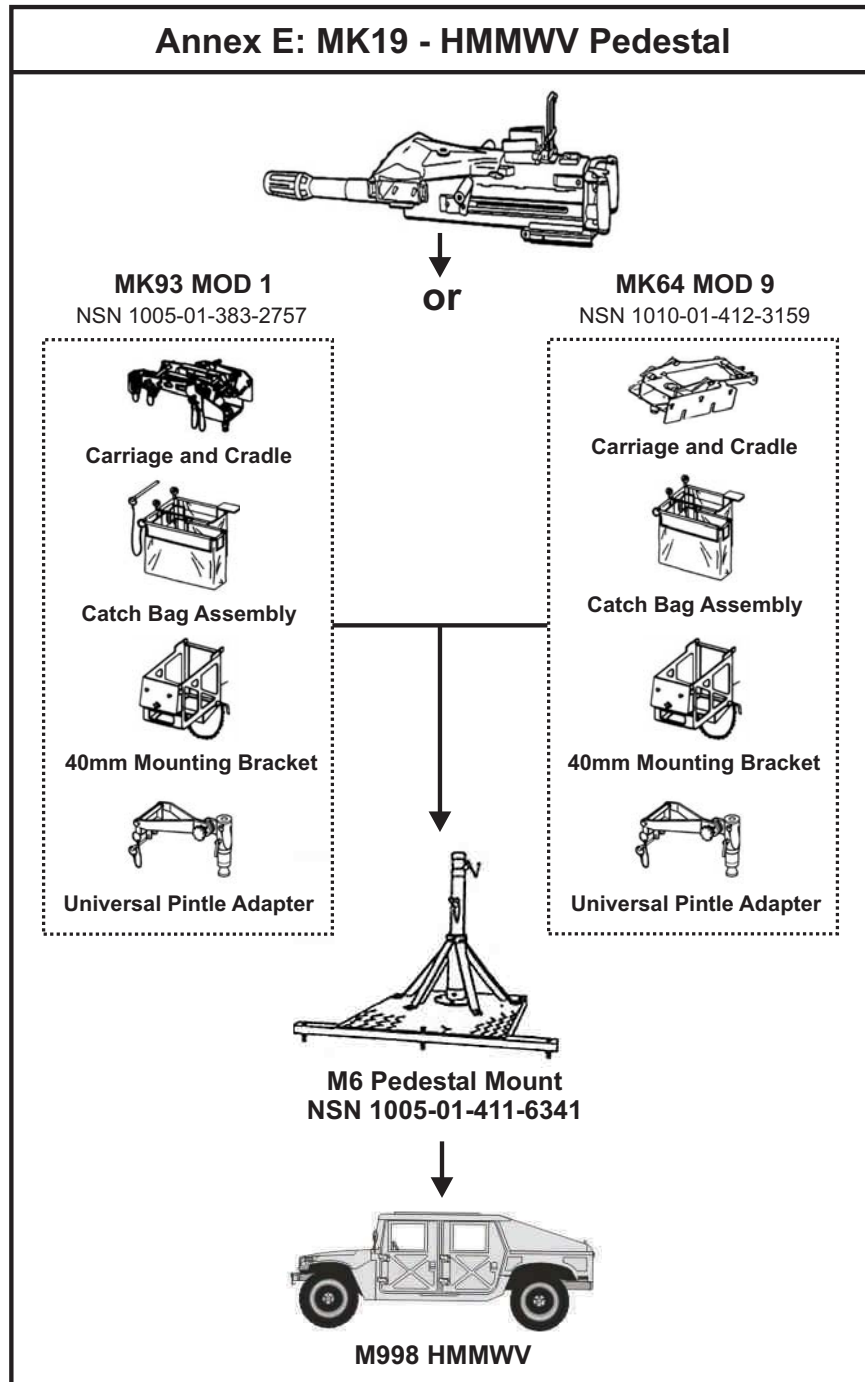

Figure Annex E-2

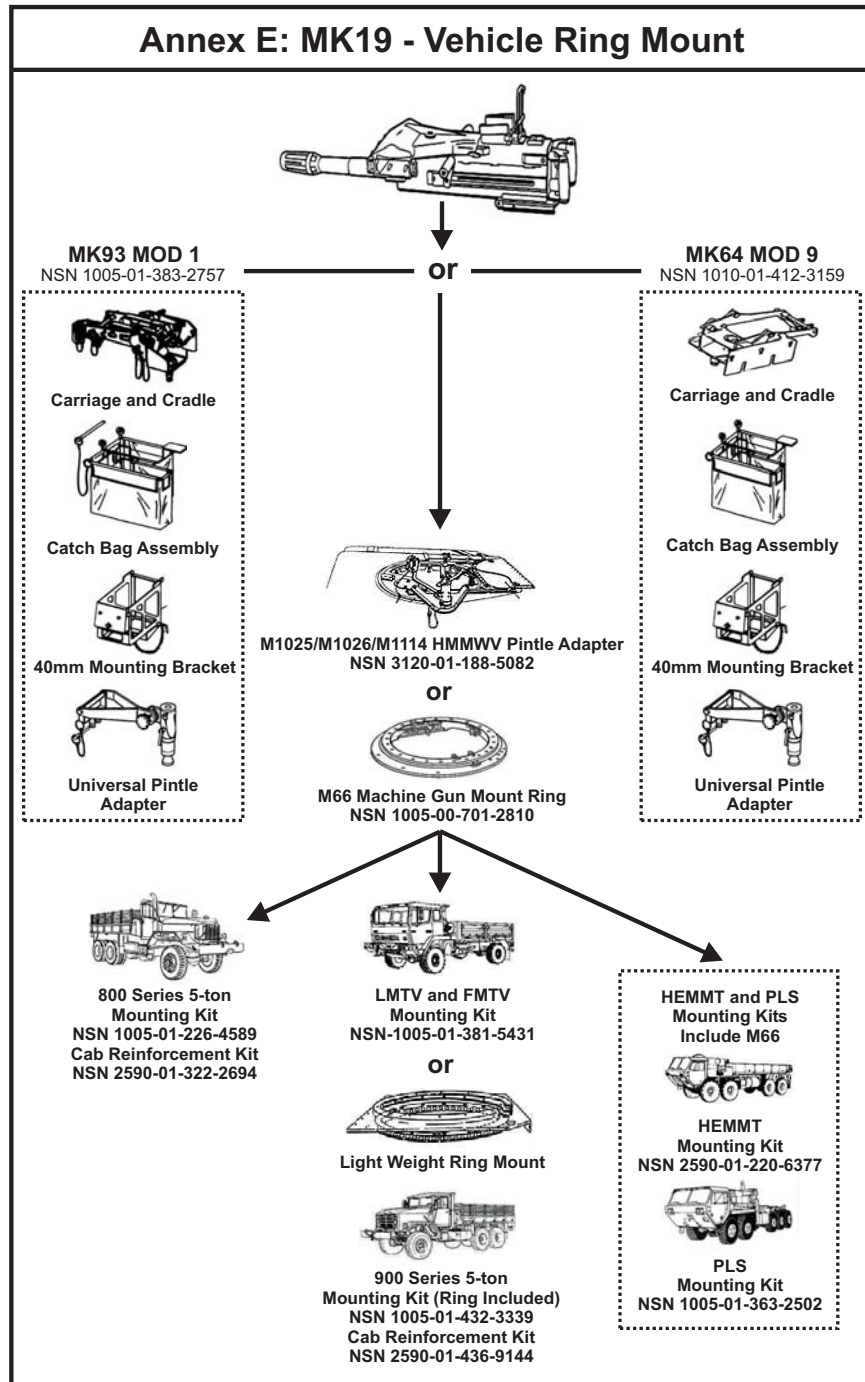

Figure Annex E-3

MK19 mounting accessories

MK93 MOD 1 NSN: 1005013832757

MK MOD 9 NSN: 1010014123159

6650 Machine gun mount NSN: 105007046650

M1025/M1026/M1114 HMMWV pintle adapter NSN: 3120011885082

M66 machinegun mount ring NSN: 1005007012810

800 series 5 ton mounting kit NSN: 1005012264589

Cab reinforcement kit NSN: 2590013222694

Light medium tactical vehicle (LMTV) and family of medium tactical vehicles (FMTV) mounting kit NSN:1005013815431

Heavy expended mobility tactical truck (HEMTT) mounting kit NSN: 2590012206377 (includes M66 ring mount)

Lightweight ring mounting kit for 900 series 5 ton NSN:1005014323339

Cab reinforcement kit NSN: 2590014369144

Annex F

QA/QC CHECKLIST			
DATE:	FINAL EVALUATION		
LOCATION:	CIRCLE FINAL RESULTS BELOW		
UNIT:	NO FAULTS		
ADMINISTRATION (ADMIN). NO.: MODEL:	SATISFACTORY		
OPERATOR:	UNSATISFACTORY:		
SENIOR OCCUPANT:	ADMIN.	PREVENTIVE MAINTENANCE CHECKS AND SERVICES (PMCS)	ADMIN & PMCS
UNIT PHONE:			
1. OPERATOR QUALIFICATIONS	GO	NO GO	REASON
a. Military Operators License			
2. EQUIPMENT RECORDS FOLDER			
a. SF 91 Report of Motor Vehicle Accident			
b. DD Form 518, Accident ID Card 2 ea			
c. DD Form 5987-E, Motor Equipment Utilization Record			
d. DD Form 5988-E, Equipment Inspection Maintenance Worksheet			
e. Operator level technical manual (-10) present?			
3. DISPATCH			
a. Off post and/or extended dispatch authorized by commander?			
b. DD Form 5987-E properly annotated with authorized Amber/Red during hazardous road conditions? Captain/GS 12 or higher			

CENTER FOR ARMY LESSONS LEARNED

4. SENIOR OCCUPANT DUTIES AND RESPONSIBILITIES			
a. Is the senior occupant an noncommissioned officer or higher?			
b. Does senior occupant know his duties and responsibilities?			
c. Did they inspect the dispatch and drivers qualifications?			
d. Do they know their duties during movement?			
5. SAFETY EQUIPMENT			
a. Complete Highway Warning Kit?			
b. Validated serviceable fire extinguisher?			
Vehicles carrying Class V required 2 ea. (1 inside, 1 out)			
c. Complete First Aid Kit?			
d. Chock block/s (greater than 1-1/4 ton req. 2 ea.) present?			
e. Operator's vehicle maintenance/basic issue item (BII) equipment present? (Note: Tire changing tools for M35A2 and larger must be present)			
Note: Enter -10 item number for all non mission capable deficiencies.			
TC has verified PMCS in accordance with equipment -10, dispatch, operator qualifications, safety equipment and responsibilities.	TC NAME PRINT	SIGNATURE	

QA/QC CHECKLIST (continued)			
UNIT:		BUMPER:	
PREVENTIVE MAINTENANCE CHECKS & SERVICES	GO	NO GO	REMARKS
OPERATOR LEVEL-			
1. Headlights operative?			
2. Tail lights operative?			
3. Brake lights operative?			
4. Turn signals operative?			
5. Emergency flashing signals operative?			
6. Traffic horn operative?			
7. Side and/or rear mirrors serviceable?			
8. Windshield, side, and rear windows serviceable?			
9. Windshield wipers serviceable?			
10. Tires serviceable? (ref. -10 ___)			
11. Wheel stud and lug nuts serviceable? (ref -10)			
12. Spare tire serviceable?			
13. Canvas or tarp serviceable? (must be present w/ troops)			
14. Troop seats serviceable? (must be present w/ troops)			
15. Safety strap serviceable? (must be present w/ troops)			
16. Seat belts serviceable? (ref. -10)			
17. Hand brake/parking brake operative? (ref. -10)			
18. Drive belts serviceable? (ref. -10)			
19. Fuel system functional? (no leaks ref. -10)			
20. If carrying cargo, is it properly secured? (ref. AR 385-55)			
21. Class II brake fluid leak on high mobility multipurpose wheeled vehicle (HMMWV) series? (ref. -10, par. 2-6)			
22. Class III oil (engine, transmission, transfer) leaks?			
23. Battery terminals serviceable (clean or loose)?			

CENTER FOR ARMY LESSONS LEARNED

24. Battery box and components serviceable, secure? (ref. -10)			
25. Engine crankcase oil level correct? (ref. -10)			
26. Transmission fluid correct? (ref. -10)			
27. Transfer oil level correct? (ref. -10)			
28. Brake fluid level correct? (ref. -10)			
29. Drive train (U-joints) properly lubricated? (ref. -12)			
30. Controls and instruments operational (All gauges normal readings)?			
31. Fire extinguisher missing, seal broken, or discharged? (ref. -10)			
UNIT LEVEL MAINTENANCE PERSONNEL			
1. Heating system serviceable (Oct-Apr)?			
2. Fan blade assembly secure?			
3. Cooling system serviceable?			
4. Exhaust system serviceable?			
5. Steering system serviceable?			
6. Drive train (loose/missing bolts) serviceable?			
7. Dust or CV boots serviceable?			
8. Brake system serviceable?			
9. Alternator mounting hardware secure & connections serviceable?			
10. Starter properly secured (especially HUMMWV)?			
11. Starter connection secure & serviceable?			
12. Engine mounting bolts secure?			
13. Transmission mounting bolts secure?			
14. Transfer mounting bolts secure?			
15. Air intake system serviceable?			
16. Air system serviceable?			
ADDITIONAL COMMENTS:			

Annex G

Reports

Medical Evacuation (MEDEVAC) Request

9-line MEDEVAC Report:

- Line 1 6 digit grid location of pick up site
- Line 2 Radio frequency, call sign, and suffix of requesting element
- Line 3 Number of patients by precedence
A- Urgent –Loss of life or limb within 2 hours
B- Urgent- Surgical
C- Priority- Loss of life or limb within 4 hours
D- Routine-Evacuation within 24 hours
E- Convenience-When time permits
- Line 4 Special equipment required
A- None
B- Hoist
C- Extraction equipment
D- Ventilator
- Line 5 Number of patients by type (litter or ambulatory)
- Line 6 Security of pickup site (possible danger/enemy situation in area)
- Line 7 Method of marking pick up site
A- VS17 panel
B- Pyro
C- Smoke (color)
D- None
E- Other
- Line 8 Patient nationality and status
A- U.S. Military
B- U.S. Civilian
C- Non-U.S. Military
D- Enemy Prisoner of War
- Line 9 CBRNE contamination
C Chemical
B Biological
R Radiological

CENTER FOR ARMY LESSONS LEARNED

N Nuclear
E High-yield explosives

IED/UXO Report

Line 1- Date/time/group discovered
Line 2- Reporting unit and grid coordinates of item found
Line 3- Method of contacting unit (radio frequency and call sign)
Line 4- Type of munitions (dropped, placed, projected, or thrown)
Line 5- CBRNE contamination
Line 6- Resources threatened (military/civilian population)
Line 7- Impact on mission
Line 8- Protective measures taken (5 Cs)
Line 9- Recommended priority (immediate, indirect, minor, or now threat)

Spot Report

Who (Unit or personnel involved in the incident)
What (Detailed description of the incident)
Where (Grid coordinates of the incident)
When (Date time group)
Actions taken by unit

SALUTE Report

Size (What is the size of the element?)
Activity (What are they doing?)
Location (Grid coordinates of element)
Unit (Describe the element involved)
Time (Date time group of observation)
Equipment (What equipment do they possess?)

Contact Report (internal to the convoy)

Call sign: Convoy commander, this is Truck 6, CONTACT!
Direction: 3 o'clock
Distance: 200 meters
Type of threat: Rocket propelled grenade and small arms

ACE Report

Ammunition (How much of the basic load remains)
Casualties (How many and by priority)
Equipment (Type and severity of damage)

PROVIDE US YOUR INPUT

To help you access information quickly and efficiently, Center for Army Lessons Learned (CALL) posts all publications, along with numerous other useful products, on the CALL Web site. The CALL Web site is restricted to U.S. government and allied personnel.

PROVIDE FEEDBACK OR REQUEST INFORMATION

[<http://call.army.mil>](http://call.army.mil)

If you have any comments, suggestions, or requests for information (RFIs), use the following links on the CALL home page: "Request for Information or a CALL Product" or "Give Us Your Feedback."

**PROVIDE TACTICS, TECHNIQUES, AND PROCEDURES (TTP) OR
SUBMIT AN AFTER ACTION REVIEW (AAR)**

If your unit has identified lessons learned or TTP or would like to submit an AAR, please contact CALL using the following information:

Telephone: DSN 552-9569/9533; Commercial 913-684-9569/9533

Fax: DSN 552-4387; Commercial 913-684-4387

NIPR e-mail address: call.rfimanager@conus.army.mil

SIPR e-mail address: call.rfiagent@conus.army.smil.mil

Mailing Address: Center for Army Lessons Learned, ATTN: OCC, 10 Meade Ave., Bldg 50, Fort Leavenworth, KS 66027-1350.

TO REQUEST COPIES OF THIS PUBLICATION

If you would like copies of this publication, please submit your request at: [<http://call.army.mil>](http://call.army.mil). Use the "Request for Information or a CALL Product" link. Please fill in all the information, including your unit name and official military address. Please include building number and street for military posts.

CENTER FOR ARMY LESSONS LEARNED

PRODUCTS AVAILABLE “ONLINE”

CENTER FOR ARMY LESSONS LEARNED

Access and download information from CALL’s Web site. CALL also offers Web-based access to the CALL Archives. The CALL home page address is:

<<http://call.army.mil>>

CALL produces the following publications on a variety of subjects:

- **Combat Training Center Bulletins, Newsletters, and Trends**
- **Special Editions**
- *News From the Front*
- **Training Techniques**
- **Handbooks**
- **Initial Impressions Reports**

You may request these publications by using the “Request for Information or a CALL Product” link on the CALL home page.

COMBINED ARMS CENTER (CAC) Additional Publications and Resources’

The CAC home page address is:

<<http://usacac.army.mil/cac2/index.asp>>

Battle Command Knowledge System (BKS)

BCKS supports the online generation, application, management, and exploitation of Army knowledge to foster collaboration among Soldiers and units in order to share expertise and experience, facilitate leader development and intuitive decision making, and support the development of organizations and teams. Find BCKS at <<http://usacac.army.mil/cac2/bcks/index.asp>>.

Center for Army Leadership (CAL)

CAL plans and programs leadership instruction, doctrine, and research. CAL integrates and synchronizes the Professional Military Education Systems and Civilian Education System. Find CAL products at <<http://usacac.army.mil/cac2/cal/index.asp>>.

Combat Studies Institute (CSI)

CSI is a military history think tank that produces timely and relevant military history and contemporary operational history. Find CSI products at <<http://usacac.army.mil/cac2/csi/csipubs.asp>>.

Combined Arms Center-Training: The Road to Deployment

This site provides brigade combat teams, divisions, and support brigades the latest road to deployment information. This site also includes U.S. Forces Command's latest training guidance and most current Battle Command Training Program Counterinsurgency Seminars. Find The Road to Deployment at <http://rtd.leavenworth.army.smil.mil> (requires SIPRNET password and ID).

Combined Arms Doctrine Directorate (CADD)

CADD develops, writes, and updates Army doctrine at the corps and division level. Find the doctrinal publications at either the Army Publishing Directorate (APD) <http://www.usapa.army.mil> or the Reimer Digital Library <http://www.adtdl.army.mil>.

Foreign Military Studies Office (FMSO)

FMSO is a research and analysis center on Fort Leavenworth under the TRADOC G2. FMSO manages and conducts analytical programs focused on emerging and asymmetric threats, regional military and security developments, and other issues that define evolving operational environments around the world. Find FMSO products at <http://fmso.leavenworth.army.mil/>.

Military Review (MR)

MR is a revered journal that provides a forum for original thought and debate on the art and science of land warfare and other issues of current interest to the U.S. Army and the Department of Defense. Find MR at <http://usacac.army.mil/cac2/militaryreview/index.asp>.

TRADOC Intelligence Support Activity (TRISA)

TRISA is a field agency of the TRADOC G2 and a tenant organization on Fort Leavenworth. TRISA is responsible for the development of intelligence products to support the policy-making, training, combat development, models, and simulations arenas. Find TRISA Threats at <https://dcsint-threats.leavenworth.army.mil/default.aspx> (requires AKO password and ID).

Combined Arms Center-Capability Development Integration Directorate (CAC-CDID)

CAC-CDIC is responsible for executing the capability development for a number of CAC proponent areas, such as Information Operations, Electronic Warfare, and Computer Network Operations, among others. CAC-CDID also teaches the Functional Area 30 (Information Operations) qualification course. Find CAC-CDID at <http://usacac.army.mil/cac2/cdid/index.asp>.

U.S. Army and Marine Corps Counterinsurgency (COIN) Center

The U.S. Army and Marine Corps COIN Center acts as an advocate and integrator for COIN programs throughout the combined, joint, and interagency arena. Find the U.S. Army/U.S. Marine Corps COIN Center at: <http://usacac.army.mil/cac2/coin/index.asp>.

Joint Center for International Security Force Assistance (JCISFA)

JCISFA's mission is to capture and analyze security force assistance (SFA) lessons from contemporary operations to advise combatant commands and military departments on appropriate doctrine; practices; and proven tactics, techniques, and procedures (TTP) to prepare for and conduct SFA missions efficiently. JCISFA was created to institutionalize SFA across DOD and serve as the DOD SFA Center of Excellence. Find JCISFA at <https://jcisfa.jcs.mil/Public/Index.aspx>.

Support CAC in the exchange of information by telling us about your successes so they may be shared and become Army successes.

CENTER FOR ARMY LESSONS LEARNED



Center for Army Lessons Learned
10 Meade Avenue, Building 50
Fort Leavenworth, KS 66027-1350

Combined Arms Center (CAC) • Ft. Leavenworth, KS

**U.S. UNCLASSIFIED
REL NATO, GCTF, ISAF, MCFI, ABCA
For Official Use Only**